

Scotsman[®]

Ice Systems

SERVICE MANUAL

NW307/308/507/508 (22inch Model)

NW457/458/608/1008/1408 (30inch Model)

Electronic Modular Cubers

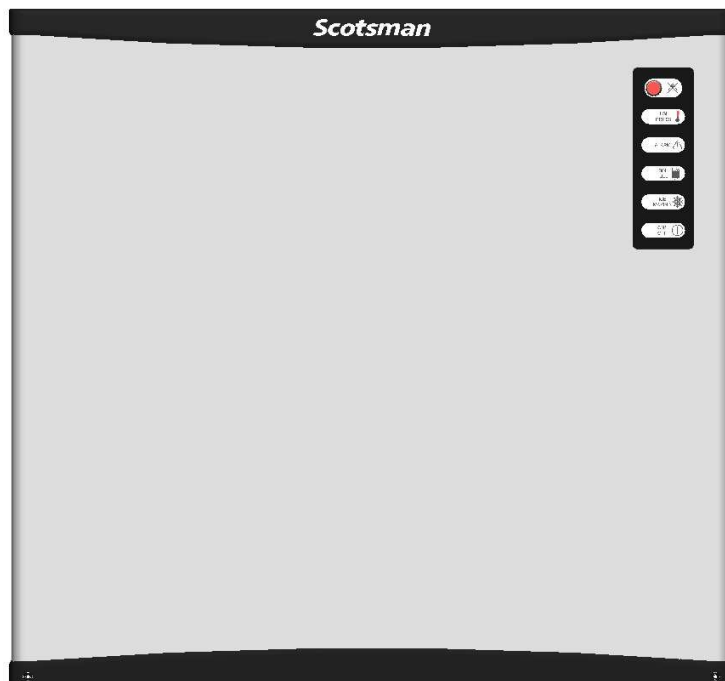

TABLE OF CONTENTS

Table of contents	1
Specifications	2-13
FOR THE INSTALLER	
Introduction	14
Storage bin	14
Standard legs	14
Important operating requirements	14
Select location	14
Storage bin	14
Ice machine	14
Air Baffle	15
Stacking instructions	15
FOR THE PLUMBER	
Conform to all applicable codes	15
Water inlet	15
Drains	16
For the electrician	16
Electrical connections	17
Final check list	18
START-UP	
Start-up cycle	19
Freezing cycle	19
Harvest cycle	20
OPERATION	
Refrigeration during freeze	21
Water system	22
Refrigeration system during harvest	23
Water system	23
Control sequence	23-24
Alarm conditions	24-25
PC Board set up	26-27
SERVICE SPECIFICATIONS	
Component	28
Operating characteristics	28
COMPONENT DESCRIPTION	
29-31	
WIRING DIAGRAM	
NW 308/508	32
NW307/507/457	33
NW 458/608	34
NW 1008 (220V)	35
NW 1008 (380V)	36
NW 1408 (380V)	37
SERVICE DIAGNOSIS	
MAINTENANCE & CLEANING INSTRUCTION	
Icemaker	38
Ice storage bin	39
Cabinet exterior	39
Cleaning (Icemaker)	40

SPECIFICATIONS

MODULAR CUBER NW 308/508



Ice Making Capacity

NW308 AIR COOLED MODELS



°C \ °F	°F			kg
	50°	70°	90°	
°F \ °C	10°	21°	32°	lbs
	10°	160	130	100
50°	352	286	220	lbs
21°	140	120	95	kg
70°	308	264	209	lbs
32°	120	105	90	kg
90°	264	231	198	lbs
38°	96	86	80	kg
100°	211	189	176	lbs



NW308 WATER COOLED MODELS



°C \ °F	°F			kg
	50°	70°	90°	
°F \ °C	10°	21°	32°	lbs
	10°	140	135	120
50°	308	297	264	lbs
21°	145	125	110	kg
70°	319	275	242	lbs
32°	130	122	103	kg
90°	286	268	226	lbs
38°	120	115	99	kg
100°	264	253	217	lbs



NW508 AIR COOLED MODELS



°C \ °F	°F			kg
	50°	70°	90°	
°F \ °C	10°	21°	32°	lbs
	10°	213	200	170
50°	469	440	374	lbs
21°	200	180	140	kg
70°	440	396	308	lbs
32°	160	145	130	kg
90°	352	319	286	lbs
38°	130	120	117	kg
100°	286	264	257	lbs



NW508 WATER COOLED MODELS



°C \ °F	°F			kg
	50°	70°	90°	
°F \ °C	10°	21°	32°	lbs
	10°	220	205	170
50°	484	451	374	lbs
21°	210	200	160	kg
70°	462	440	352	lbs
32°	200	195	155	kg
90°	440	429	341	lbs
38°	190	180	150	kg
100°	418	396	330	lbs









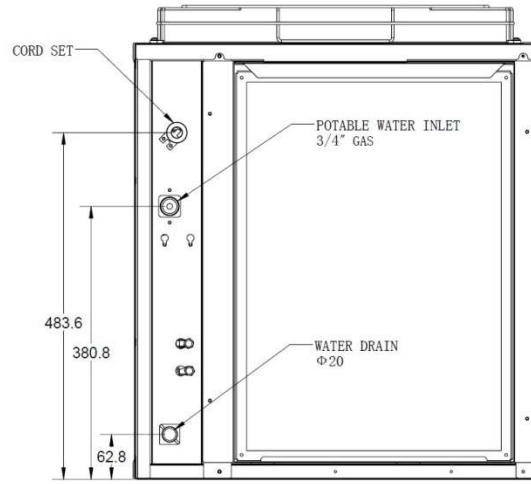
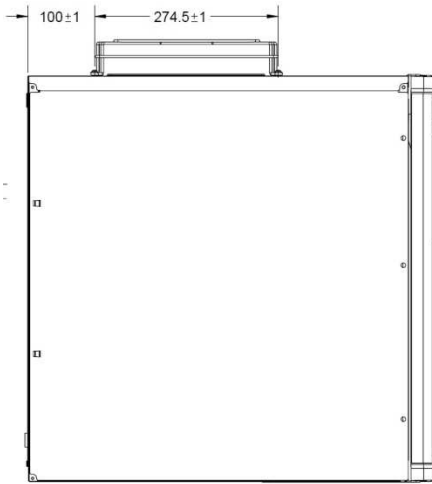
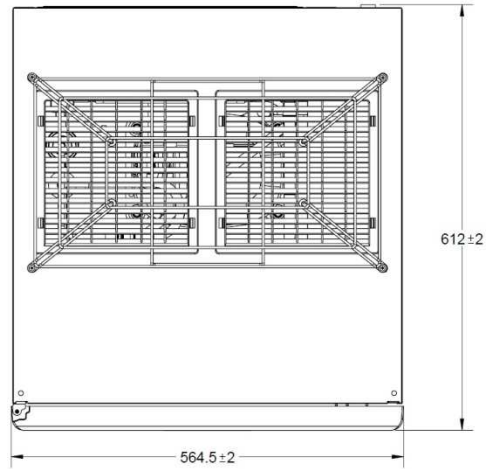
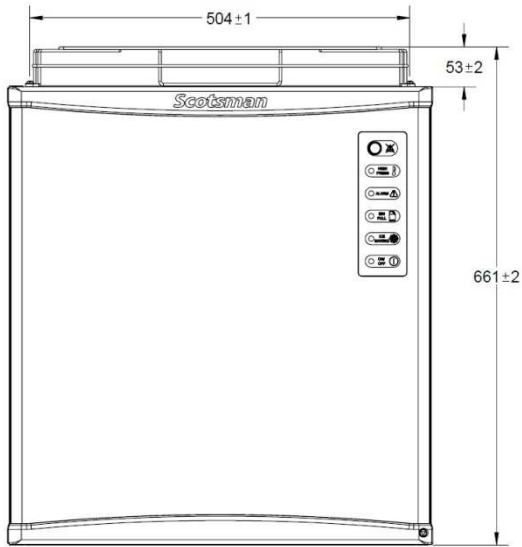



























NOTE. To keep your Modular cuber performing at its maximum capacity, it is necessary to perform periodic maintenance as outlined on page 34&35 of this manual.

SPECIFICATIONS

MODULAR CUBER NW 308/508



													
	+C -C	[BTU/h] [W]	[Ømm ²]	V/Hz/Ph	[W]	[A]	[kwh/100lbs]	[L/100lbs]	[kg] [lbs]	[kg] [lbs]	[kg] [lbs]	[kg] [lbs]	
NW308 AS		6142 1800	3×1.5	220/50/1	800	10A	7.4	80	55 121	70 154			
NW308 WS		6142 1800	3×1.5	220/50/1	700	10A	6	894	53 117	67 147			
NWH308 AS		6142 1800	3×1.5	220/50/1	800	10A	7.4	80	55 121	70 154			
NWH308 WS		6142 1800	3×1.5	220/50/1	700	10A	6	894	53 117	67 147			

													
	+C -C	[BTU/h] [W]	[Ømm ²]	V/Hz/Ph	[W]	[A]	[kwh/100lbs]	[L/100lbs]	[kg] [lbs]	[kg] [lbs]	[kg] [lbs]	[kg] [lbs]	
NW508 AS		8872 2600	3×1.5	220/50/1	1200	16A	7.1	73	65 143	80 176			
NW508 WS		8872 2600	3×1.5	220/50/1	1000	16A	4.3	775	64 141	79 174			
NWH508 AS		8872 2600	3×1.5	220/50/1	1200	16A	7.1	73	65 143	80 176			
NWH508 WS		8872 2600	3×1.5	220/50/1	1000	16A	4.3	775	64 141	79 174			

SPECIFICATIONS

MODULAR CUBER NW 307/507/457



Ice Making Capacity

NW307 AIR COOLED MODELS



°C \ °F	50°	70°	90°	
	10°	21°	32°	
10°	160	130	100	kg
50°	352	286	220	lbs
21°	160	125	100	kg
70°	352	275	220	lbs
32°	130	120	95	kg
90°	286	264	209	lbs
38°	100	90	85	kg
100°	220	198	187	lbs



NW507 AIR COOLED MODELS



°C \ °F	50°	70°	90°	
	10°	21°	32°	
10°	200	190	170	kg
50°	440	418	374	lbs
21°	190	170	140	kg
70°	418	374	308	lbs
32°	150	140	125	kg
90°	330	308	275	lbs
38°	120	110	100	kg
100°	264	242	220	lbs



NW457 AIR COOLED MODELS



°C \ °F	50°	70°	90°	
	10°	21°	32°	
10°	215	195	175	kg
50°	473	429	385	lbs
21°	208	186	165	kg
70°	458	409	363	lbs
32°	155	150	132	kg
90°	341	330	290	lbs
38°	132	125	102	kg
100°	290	275	224	lbs









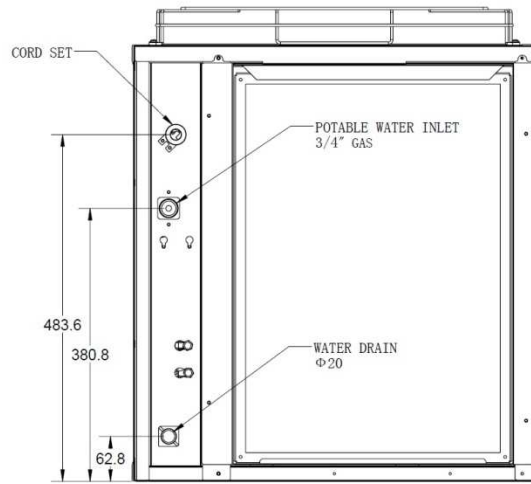
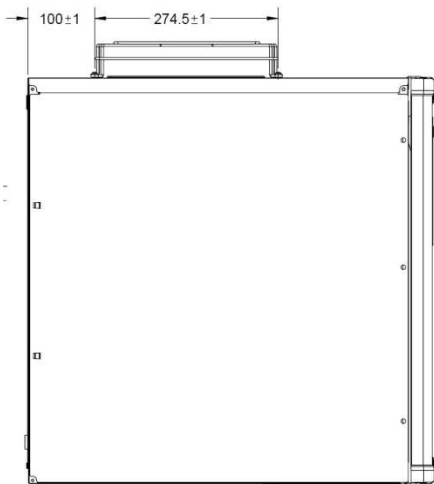
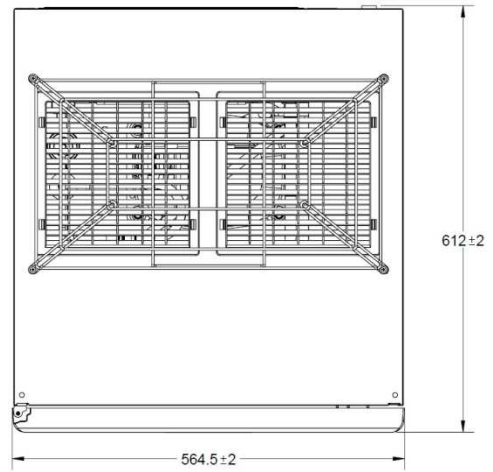
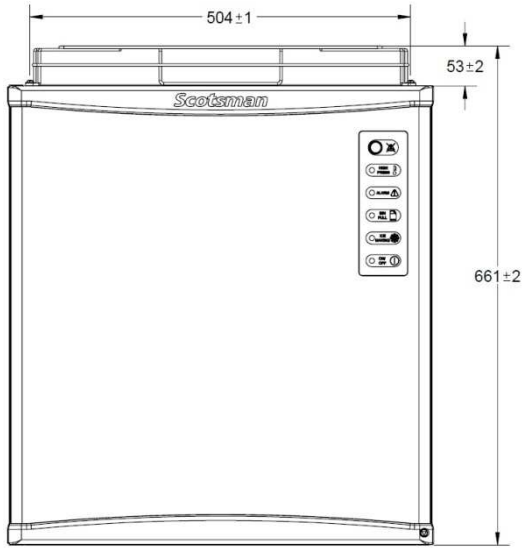



NOTE. To keep your Modular cuber performing at its maximum capacity, it is necessary to perform periodic maintenance as outlined on page 34&35 of this manual.

SPECIFICATIONS

MODULAR CUBER NW 307/507



													
		[BTU/h]	[W]	[Ømm ²]	V/Hz/Ph	[W]	[A]	[kwh/100lbs]	[L/100lbs]	[kg]	[lbs]	[kg]	[lbs]
NW307AS	✚	10035	2941	3x1.5	230/50/1	910	16 A	7.2	75	54	121	63	154
NW507AS	✚	10035	2941	3x1.5	230/50/1	1210	16 A	6.6	80	67	143	77	176

SPECIFICATIONS

MODULAR CUBER NW 458



Ice Making Capacity

NW458 AS
NWH458 AS 

°C \ °F	°F	50°	60°	70°	90°	
	°C	10°	15°	21°	32°	
10°	°F	215	207	195	175	kg
50°	°F	475	456	430	386	lbs
21°	°C	200	195	186	165	kg
70°	°C	452	440	410	364	lbs
32°	°C	152	148	146	132	kg
90°	°C	335	326	322	291	lbs
38°	°C	132	128	125	118	kg
100	°C	291	282	276	260	lbs



NW458 WS
NWH458 WS 

°C \ °F	°F	50°	60°	70°	90°	
	°C	10°	15°	21°	32°	
10°	°F	200	197	187	167	kg
50°	°F	440	434	412	368	lbs
21°	°C	197	192	182	163	kg
70°	°C	434	423	401	360	lbs
32°	°C	180	175	165	153	kg
90°	°C	397	386	364	337	lbs
38°	°C	170	165	159	146	kg
100	°C	375	364	350	322	lbs



NOTE. To keep your Modular cuber performing at its maximum capacity, it is necessary to perform periodic maintenance as outlined on page 34&35 of this manual.

SPECIFICATIONS

MODULAR CUBER NW 458/457

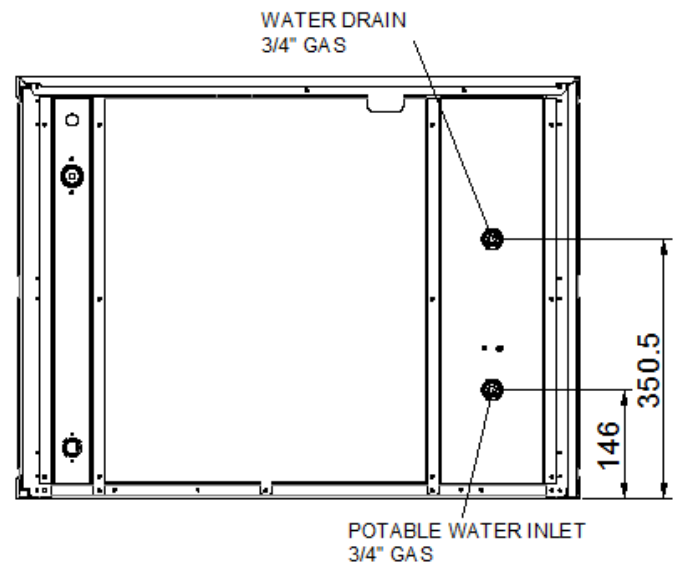
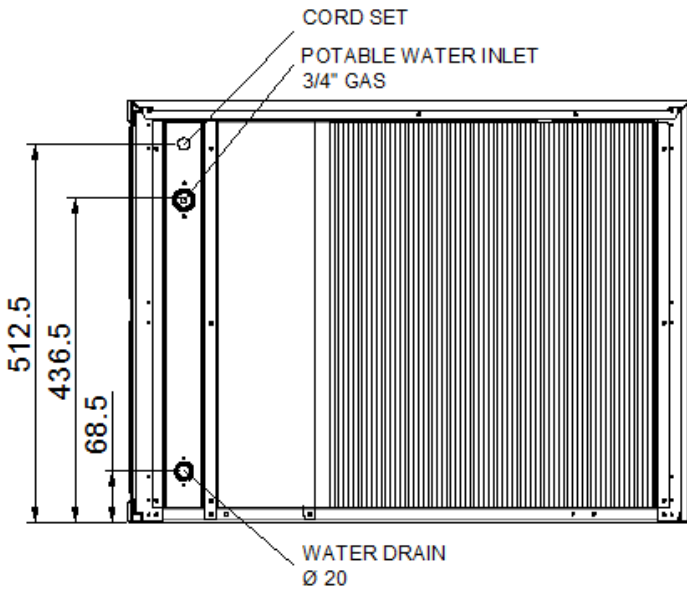
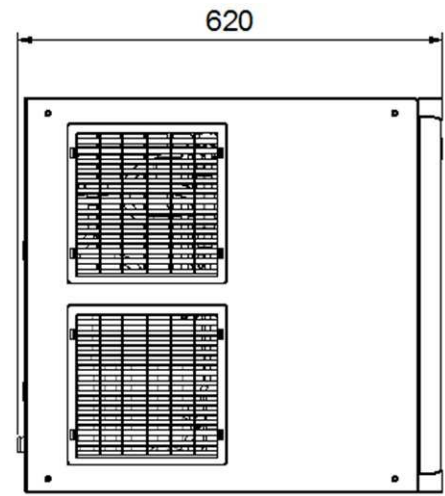
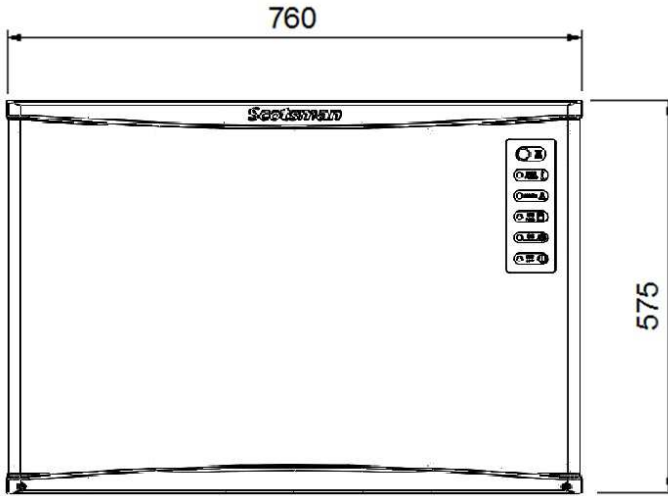

Air Cooled

Water Cooled

Model	Cooling Type	Cooling Capacity		Ice Production	Voltage/Freq/Ph	Power Input	Current	Energy Efficiency		Weight		Dimensions	
		[BTU/h]	[W]					[kwh/100lbs]	[L/100lbs]	[kg]	[lbs]	[kg]	[lbs]
NW458AS	Air Cooled	8900	2600	3x1.5	230/50/1	1000	16 A	6.47	57.9	70	154	85	187
NW458WS	Water Cooled	8900	2600	3x1.5	230/50/1	900	16 A	5.8	825	69	152	84	185
NWH458AS	Air Cooled	8900	2600	3x1.5	230/50/1	1000	16 A	6.47	57.9	70	154	85	187
NWH458WS	Water Cooled	8900	2600	3x1.5	230/50/1	900	16 A	5.8	825	69	152	84	185
NW457AS	Air Cooled	10035	2941	3x1.5	230/50/1	960	16 A	5.8	80	73	161	87	191

SPECIFICATIONS

MODULAR CUBER NW608



Ice Making Capacity

NW608 AS
NWH608 AS 



°C \ °F	°F	50°	60°	70°	90°	kg
	°C	10°	15°	21°	32°	
10°	320	305	290	260	kg	
50°	704	671	638	572	lbs	
21°	280	275	265	240	kg	
70°	616	605	583	528	lbs	
32°	225	220	210	195	kg	
90°	496	485	470	430	lbs	
38°	190	188	180	174	kg	
100	418	414	405	383	lbs	



NW608 WS
NWH608 WS 



°C \ °F	°F	50°	60°	70°	90°	kg
	°C	10°	15°	21°	32°	
10°	280	275	270	250	kg	
50°	617	606	595	551	lbs	
21°	275	270	265	245	kg	
70°	606	595	584	540	lbs	
32°	265	260	255	235	kg	
90°	584	573	562	518	lbs	
38°	250	245	240	225	kg	
100	351	340	329	296	lbs	



NOTE. To keep your Modular cuber performing at its maximum capacity, it is necessary to perform periodic maintenance as outlined on page 34&35 of this manual.

SPECIFICATIONS



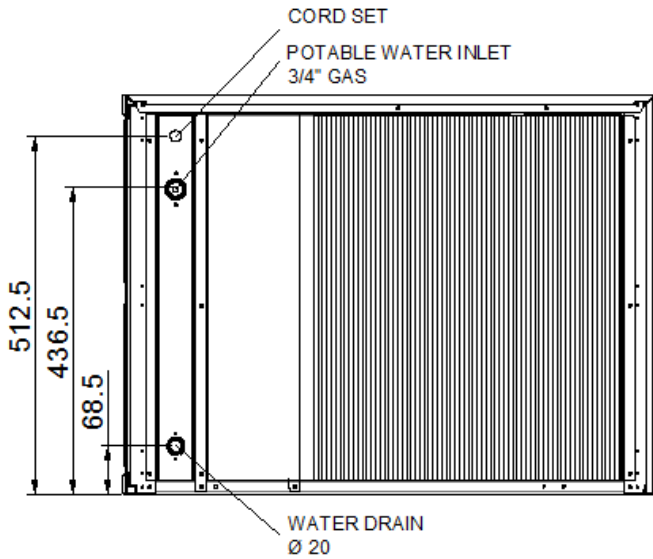
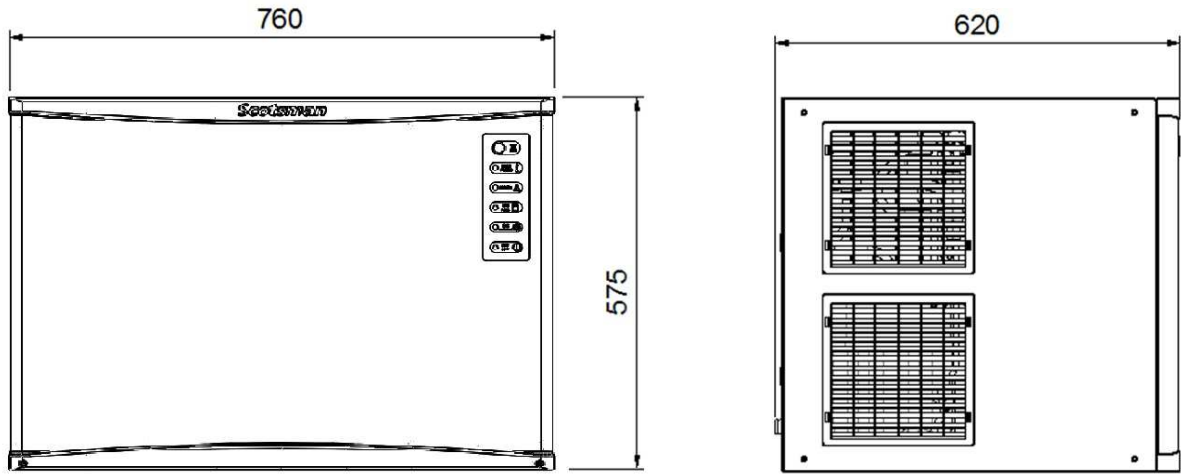



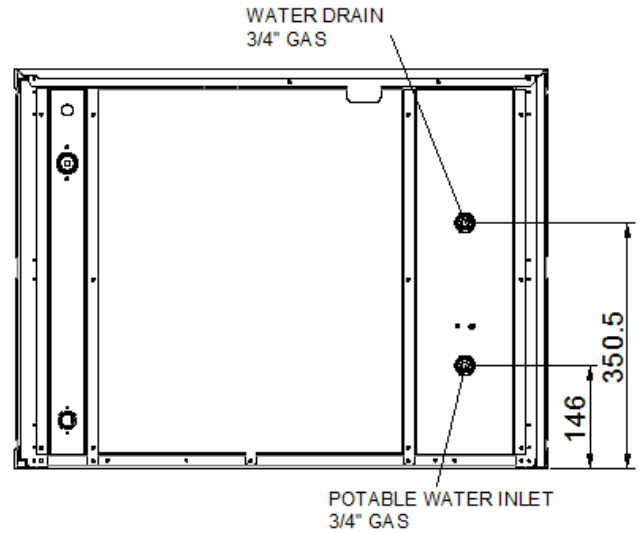



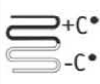





MODULAR CUBER NW608



Air Cooled



Water Cooled

													
		[BTU/h] [W]	[Ømm ²]	V/Hz/Ph	[W]	[A]	[kwh/100lbs]	[L/100lbs]	[kg] [lbs]	[kg] [lbs]	[kg] [lbs]	[kg] [lbs]	
NW608AS		16600 4850	3x1.5	230/50/1	1600	16 A	7.41	65.6	73 161	88 194			
NW608WS		16600 4850	3x1.5	230/50/1	1300	16 A	5.5	720	72 158	87 191			
NW608HAS		16600 4850	3x1.5	230/50/1	1600	16 A	7.41	65.6	73 161	88 194			
NW608HWS		16600 4850	3x1.5	230/50/1	1300	16 A	5.5	720	72 158	87 191			

SPECIFICATIONS

MODULAR CUBER NW1008



Ice Making Capacity

NW1008 AS
NWH1008 AS 



°C °F	°F °C	50°	60°	70°	90°	kg lbs
		10°	15°	21°	32°	
10°		485	472	457	430	kg
50°		1067	1038	1005	946	lbs
21°		456	445	432	408	kg
70°		1003	979	950	897	lbs
32°		390	378	365	340	kg
90°		858	831	803	748	lbs
38°		330	322	315	300	kg
100		726	708	693	660	lbs



NW1008 WS
NWH1008 WS 



°C °F	°F °C	50°	60°	70°	90°	kg lbs
		10°	15°	21°	32°	
10°		450	435	410	375	kg
50°		990	957	902	825	lbs
21°		445	430	405	370	kg
70°		979	946	891	814	lbs
32°		435	420	395	365	kg
90°		957	924	869	803	lbs
38°		415	405	380	355	kg
100		913	891	836	781	lbs



NOTE. To keep your Modular cuber performing at its maximum capacity, it is necessary to perform periodic maintenance as outlined on page 34&35 of this manual.





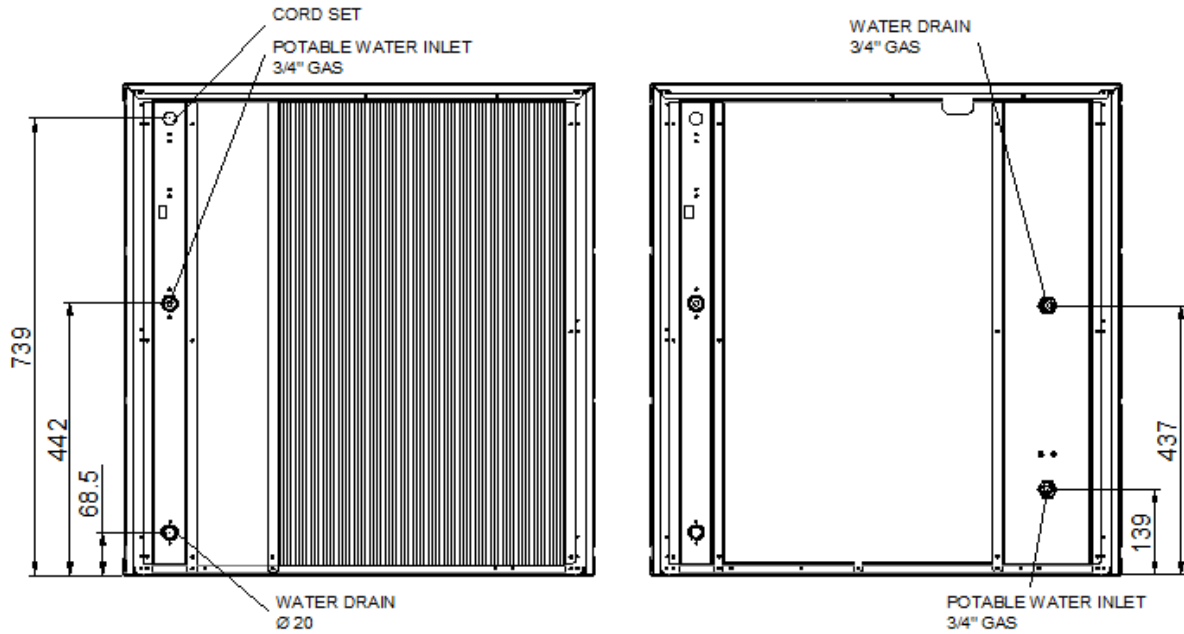
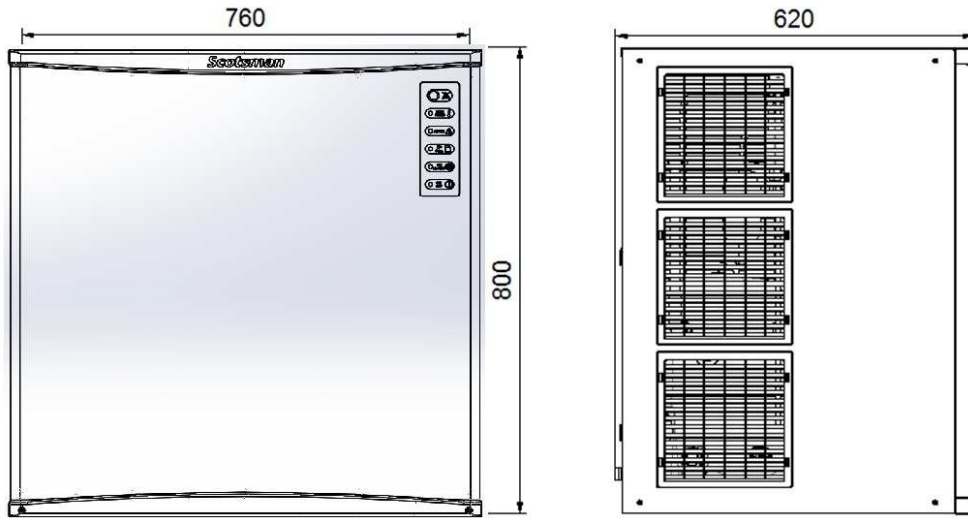













SPECIFICATIONS

MODULAR CUBER NW1008



Air Cooled

Water Cooled

													
		[BTU/h]	[W]	[Ømm ²]	V/Hz/Ph	[W]	[A]	[kwh/100lbs]	[L/100lbs]	[kg]	[lbs]	[kg]	[lbs]
NW1008AS		24900	7300	5x2.5	380/50/3	2500	10A	5.96	64.3	104	228	122	268
NW1008WS		24900	7300	5x2.5	380/50/3	2500	10A	5.5	474.1	100	220	110	243
NW1008HAS		24900	7300	5x2.5	380/50/3	2500	10A	5.96	64.3	104	228	122	268
NW1008HWS		24900	7300	5x2.5	380/50/3	2500	10A	5.5	474.1	100	220	110	243
NW1008AS		24900	7300	3x2.5	230/50/1	2500	30A	5.96	64.3	104	228	122	268
NW1008HAS		24900	7300	3x2.5	230/50/1	2500	30A	5.5	64.3	104	228	122	268

SPECIFICATIONS

MODULAR CUBER NW1408



Ice Making Capacity

NW1408 AIR COOLED MODELS



°C \ °F	50°	70°	90°	
	10°	21°	32°	
10°	680	600	550	kg
50°	1496	1320	1210	lbs
21°	630	590	490	kg
70°	1386	1298	1078	lbs
32°	560	500	450	kg
90°	1232	1100	990	lbs
38°	504	403	370	kg
100°	1109	886.6	814	lbs



NW1408 WATER COOLED MODELS



°C \ °F	50°	70°	90°	
	10°	21°	32°	
10°	680	630	550	kg
50°	1496	1386	1210	lbs
21°	660	620	520	kg
70°	1452	1364	1144	lbs
32°	630	600	500	kg
90°	1386	1320	1100	lbs
38°	590	550	490	kg
100°	1298	1210	1078	lbs





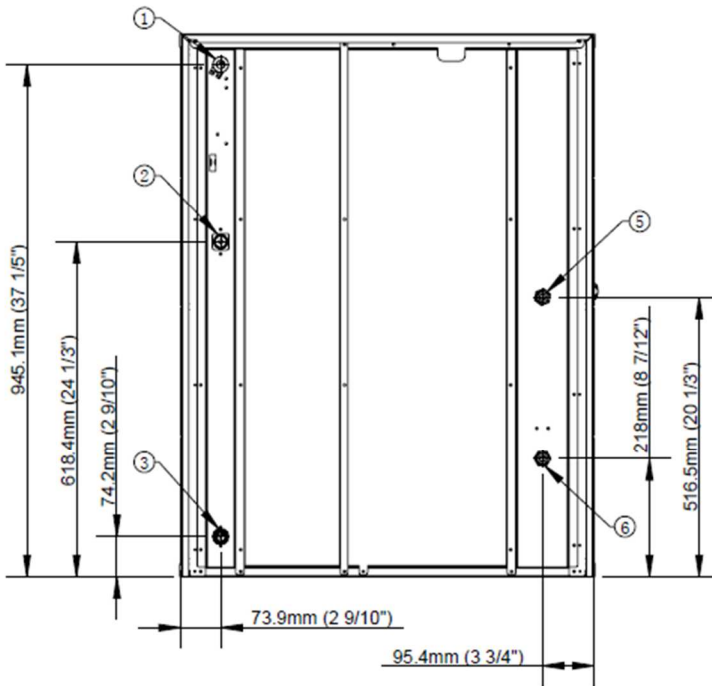
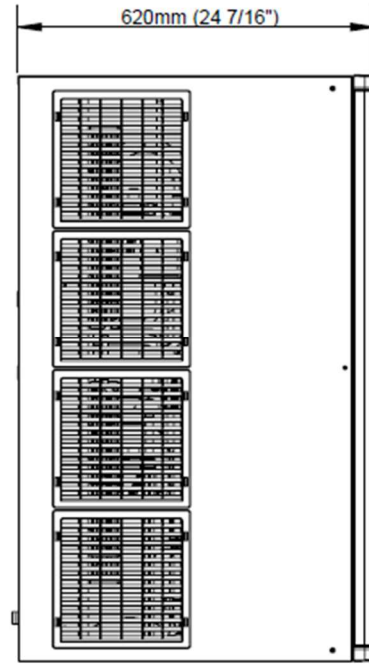
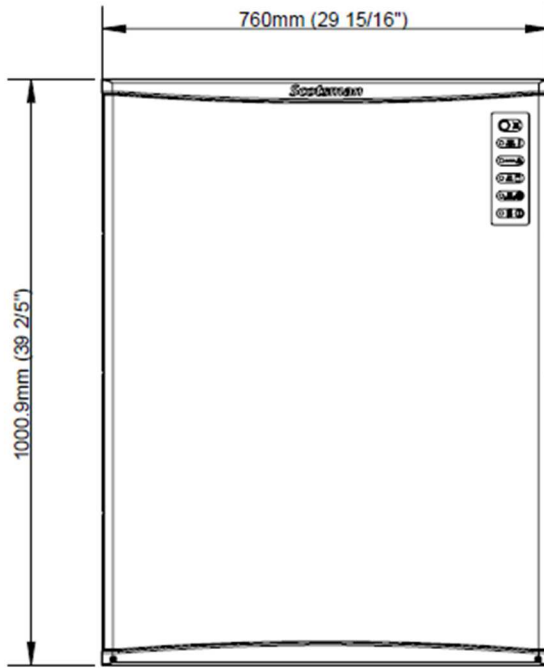















NOTE. To keep your Modular cuber performing at its maximum capacity, it is necessary to perform periodic maintenance as outlined on page 34&35 of this manual.



UNIT OF MEASUREMENT: mm (inch)

1. POWER CORD 220V 50Hz;
2. 3/4" GAS-WATER INLET ;
3. 13/16" OD - WATER OUTLET;
4. AIR INLET / AIR FILTER;
5. 3/4" GAS-WATER OUTLET;
6. 3/4" GAS-WATER INLE .

													
	+C° -C°	[BTU/h] [W]	[Ømm ²]	V/Hz/Ph	[W]	[A]	32°C 96°F 21°C 70°F	32°C 96°F 21°C 70°F	[kg] [lbs]	[kg] [lbs]	[kg] [lbs]	[kg] [lbs]	
NWL1408AS		35800 10500	3x2.5	230/50/1	3365	30A	4.7	59	130 286	145 319	145 319	145 319	
NWL1408WS		35800 10500	3x2.5	230/50/1	3365	30A	4	550	130 286	145 319	145 319	145 319	
NW1408AS		35800 10500	3x2.5	230/50/1	3365	30A	5.1	58	130 286	145 319	145 319	145 319	
NW1408WS		35800 10500	3x2.5	230/50/1	3365	30A	4.1	490	130 286	145 319	145 319	145 319	
NWH1408AS		35800 10500	3x2.5	230/50/1	3365	30A	4.9	64	130 286	145 319	145 319	145 319	
NWH1408WS		35800 10500	3x2.5	230/50/1	3365	30A	4.2	540	130 286	145 319	145 319	145 319	

FOR THE INSTALLER

INTRODUCTION

These instructions provide the specifications and the step-by-step procedures for the installation, start up and operation for the SCOTSMAN Model NW 307-308-507-508-457-458-608-808-1008-1408 Modular Cubers. The Models NW 307-308-507-508-457-458-608-808-1008-1408 Modular Cubers are quality designed, engineering and constructed, and are thoroughly tested ices making systems, providing the utmost in flexibility to fit the needs of a particular user.

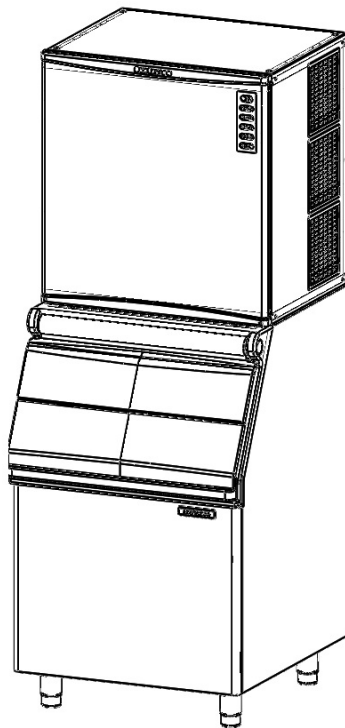

INSTALLATION NOTE: Allow 15 minimum space at sides and back for ventilation and utility connections.

STORAGE BIN

NW 307-308-507-508-457-458-608-808-1008-1408 can stack onto SCOTSMAN bin model NB 193-393-530-948 SCOTSMAN bin.

Refrigerant R290/R404A/R452A

Charge per nameplate rating.

R290 only for NW307/507/457

STANDARD LEGS: Furnished with storage bin. Four legs screw into mounting sockets on cabinet base. Provide 14-17 cm height

including adjustable leveling foot.

IMPORTANT OPERATING REQUIREMENTS

Air Temperature	MINIMUM 10 °C(50°F)	MAXIMUM 40°C (100°F)
Water Temperature	5°C (40°F)	35°C (90°F)
Water Pressures	1 bar gauge	5 bar gauge
Electrical Voltage Variations Voltage rating specified on nameplate	-10%	+10%

Extended periods of operation exceeding these limitations constitute misuse under the terms of Manufacturer's Limited Warranty, resulting in a loss of warranty coverage.

SELECT LOCATION

The first step in installing the equipment is to select the location. The purchaser of the unit will have a desired spot in mind, check out that spot to insure that it is:

- Indoors, in an environment that does not exceed the air and water temperature limitations for the equipment.
- That the necessary utilities are available including the correct voltage electrical power.
- that there be space around the installed machine for service, 15 cm. minimum left, right, and rear for air-cooled models.

STORAGE BIN

The Scotsman bins for these units are the NB 193, NB393, NB530 and NB948.

Other bins may be available with bin tops to vary the storage capacity. Lay the bin on its back, using cardboard from the carton to support it, screw in the legs.

Stand the bin upright, and correct any possible small tears in the machine mounting gasket with food grade silicone sealant.

ICE MACHINE

The use of a mechanical lift is recommended for lifting the uncrated icemaker onto the bin. Remove front, top and sides panels.

Place the unit directly onto the bin, align it with the back of the bin. Locate the hardware package, take out two mounting screws, and

use them to secure the Icemaker to the two sides of the bin.
See illustration below.

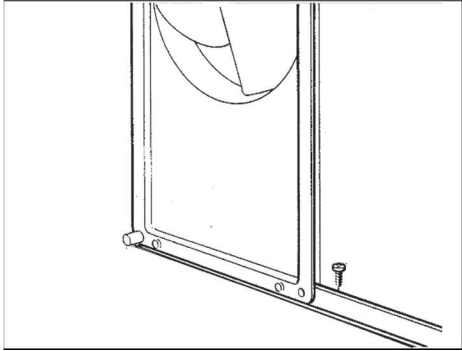

Remove all shipping material as well as the masking tapes from the ice Deflector/evaporator cover.



Remove first the ice deflector/evaporator cover then the masking tape from the ice thickness sensor.



AIR BAFFLE

Install on the back side of the machine the air baffle as per instruction provided with it.

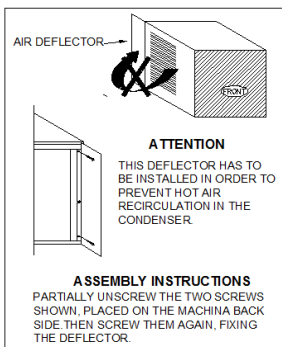

STACKING INSTALLATION

To stack a second NW onto the present one, first remove the top panel from the lower machine. Add a bead of food grade silicone sealant to the top edges of the lower units freezing compartment. Lift the top machine onto the bottom machine, (the use of a mechanical lift is recommended for this step). Align the two machines cabinets, and using the 2 screw from the top units, hardware package, fasten the two units together at the side cabinets.

Then make use of the Stacking Kit KSC 450, and KSC 1000, to be mounted as per fitting instructions included in their package, respectively on NW 458, NW608, NW1008 located in the bottom for proper conveying, of the ice cubes made by the top unit, into the storage bin.

With food grade silicone perfectly seal the edge between the freezing compartment of the upper machine and of the bottom machine so to avoid any possible leak of water through the clearance in between.

(Note: NW 307/308/507/508/457/1408 NOT DESIGNED FOR STACKING.)

FOR THE PLUMBER

CONFORM TO ALL APPLICABLE CODES

When choosing the water supply for the NW Cuber, consideration should be given to:

- A. Length of run.
- B. Water clarity and purity.
- C. Adequate water supply pressures.

Since water is the most important single ingredient in producing ice you cannot over emphasize the three items listed above. Low water pressure, below 1 bar may cause malfunction, of the icemaker unit. Water containing excessive minerals will tend to produce cloudy colored ice cubes, plus scale build-up on parts in the water system. Heavily chlorinated water can be controlled using charcoal or carbon filters.

WATER INLET

AIR-COOLED MODELS: The recommended water supply is cold water connected to the - 3/4" gas - male fitting at the back of the cabinet.

Install a hand valve near the machine to control the water supply.

DRAINS

AIR-COOLED MODELS: There is one 20 mm. diameter sump drain fitting at the back of the cabinet. Insulations in high humidity areas is recommended. The ideal drain receptacle would be a trapped and vented floor drain.

STORAGE BIN: A separate gravity type drain needs to be run, similar to the air-cooled sump drain. Insulation of this drain line is recommended.

FOR THE ELECTRICIAN

ELECTRICAL CONNECTIONS

The unit comes equipped with an electrical cord for power supply. The lead wires must be connected to an electrical plug that corresponds to the local electrical codes and

requirements or to a separate two poles disconnect box with opening to the contacts of about 3 millimeters. The disconnect box should be placed close to the selected ice maker location to be easily and prompt reached. Undersized wiring or improperly installed electrical circuit will result in major problems and malfunctions. Voltage variations should not exceed ten percent.

IMPORTANT - All plumbing and electrical connections must be made by licensed plumbers and electricians, this one must follow the electrical specifications printed on the ice maker nameplate.

NOTE: All SCOTSMAN Cubers require a neutral wire and a solid earth ground wire to prevent possible severe Electrical Shock Injury to individuals or extensive damage to equipments.

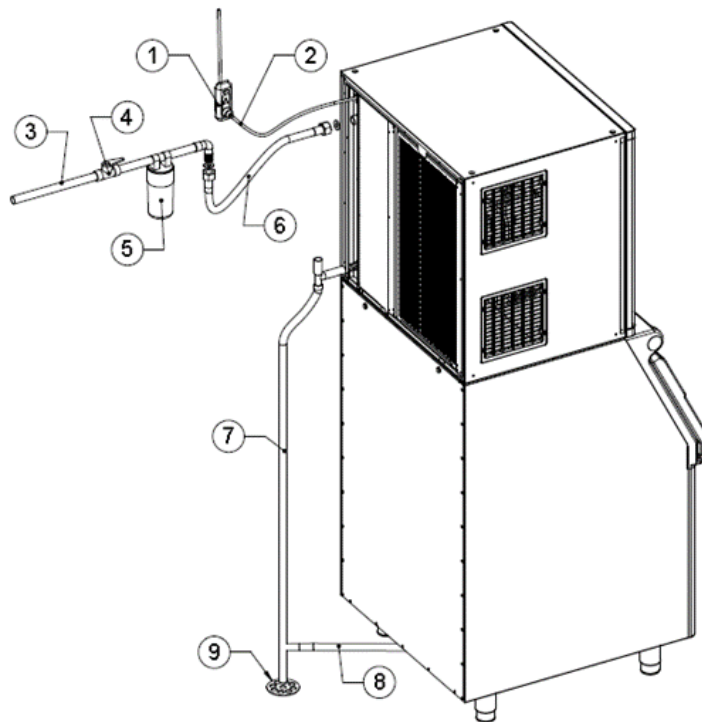

- 1) Plug receptacle
- 2) Electrical plug
- 3) Water inlet
- 4) Shut-off valve
- 5) Water filter

- 6) Water inlet line
- 7) Water outlet line
- 8) Bin water outlet line
- 9) Open vented water drain

FINAL CHECK LIST

1. Is the cabinet/bin level?
2. Is the cuber in a location where ambient temperatures are a minimum of 10°C (50°F) all year around and to not exceed a maximum of 40°C. (100°F.)
3. Is there at least a 15 cm. clearance behind and around the cabinet for all connections and for proper air circulation?
4. Have all electrical and piping connections been made?
5. Has the electrical power supply wiring been properly connected and the voltage tested and checked against the nameplate rating? Has the unit properly grounded?
6. Is the water supply line shutoff valve installed and opened and has the inlet water supply pressure been checked to insure a minimum of 1 bar without exceeding a maximum of 5 bar.

7. Have the compressor hold down bolts been checked to be sure the compressor is snug on the mounting pads.
 8. Check all refrigerant lines and conduit lines to against vibration and possible failure.
 9. Has the cuber and the bin been wiped clean with clean damp cloths?
 10. Has the owner/user been given the user manual and instructed on how to operate the icemaker and the importance of periodic maintenance?
 11. Has the owner/user been given the name and telephone number of the authorized SCOTSMAN distributor or service agency serving him?
 12. Has the manufacturer's registration card been properly filled out?
- Check for correct Model and serial numbers from nameplate, and then mail the completed card to the manufacturer.

TYPICAL STACKING INSTALLATION

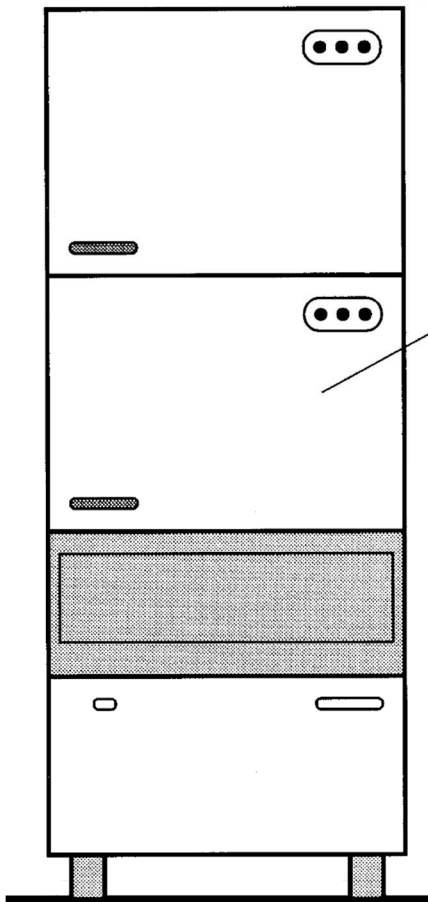

KIT STACKING KSC 450: TO STACK 2 NW 458
KIT STACKING KSC 450: TO STACK 2 NW608
KIT STACKING KSC 1000: TO STACK 2 NW 1008
(NW308/508/1408 NOT DESIGNED FOR STACKING)

START-UP

START-UP CYCLE

1. Open the water tap/valve and switch ON the power on the electrical supply line.

2. The models NW307-308-507-508-457-458-608 enter in the Start Up cycle with the PC Board energized, and NW1008/1408 enter in 90 minutes delay time controlled by PC Board, The LED of ICE MAKING blinking slow.

In Start Up cycle the LED of ICE MAKING and BIN FULL are energized, blinking slow 3 minutes for water system clean, then ICE MAKING blinking fast 40 second for pressure balance.

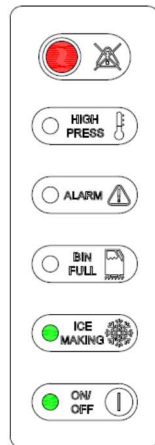

2. The LED energized are:

- Machine under power (steady)
- Machine in ICE MAKING (steady)

3. Water is coming into the water through the Water Inlet Solenoid Valve till the water reservoir is filled up to the maximum level controlled by a Water Level Sensor.



4. 40 seconds later, the Water Pump starts up.

5. After few minutes (3-5) from the start up of the freezing cycle, the Water Inlet Solenoid Valve is activated again for few seconds to refill the water reservoir up to the maximum level so to reduce any possibility of slush ice formation.

6. In the meantime the condenser sensor starts to transmit the current to the PC Board keeping in operation the Fan Motor in ON-OFF mode or continuously according to the condenser temperature.

NOTE:

Model NW 1008/1408 has a crankcase heater in the compressor. When the main power to the machine is switched ON, there is a time delay of 90 minutes during which only the compressor heater is energized with Green ICE Making LED Blinking slowly. However, if the ambient temperature is higher than 25°C (77°F), PC Board will automatically bypass this delay. This time delay can also be bypass by pressing the bypass switch located at the back of the machine.

NOTE: Do not remove the evaporator deflector cover as it will cause the switching off of the machine at "STORAGE BIN FULL".

3. During the start up cycle the components in operation are:

- Hot Gas valve
- Water Drain Valve
- Water Inlet Valve
- Water Pump

FREEZING CYCLE

1. After the start up cycle the machine enters directly into the freezing cycle with the following components energized:

- Water Inlet valve
- Compressor
- Fan motor.

7. The machine remains in the freezing cycle with the ice that become thicker till the two metal plates of the Ice Thickness Sensor are covered by the water cascading through the front surface of the ice plate.

8. When the Power is transmitted back to the PC Board continuously through the metal plates of the Ice Thickness Sensor for more than 6", the machine enters in the Pre-Harvest or directly into the Harvest Cycle mode according to:

• FAN MOTOR IN ON-OFF MODE DURING

Rise up the cutting temperature of the condenser sensor to 38°C (fan motor off) and extend the length of freezing cycle by 30" more the going to harvest cycle.

• FAN MOTOR ALWAYS IN OPERATION

Go straight to the harvest cycle.

9. First freezing time will range between 15 and 20 minutes. Longer time for temperature above 25 °C and shorter time required when temperature are below 25°C. Average complete cycle time is about 22 min.

HARVEST CYCLE

1. During the harvest cycle the components in operation are:

- Hot Gas valve
- Water Drain/Purge Valve
- Water Pump (According DIP Switch #6)
- Compressor

And both

- Machine under Power
- Machine in Operation

2. After beginning of Harvest Cycle, Purge Valve will according DIP Switch (#6) setup to purge water, 20" after the Purge Valve open, the Water Inlet Solenoid Valve is energized for 10 seconds only in order to have a short flush of fresh water into the sump while the Water Pump and Purge valve are still in operation.

3. The Fan Motor remains in OFF mode unless the Condenser Sensor probe rise up to more than 38°C (same set up as per end of freezing cycle).

4. When the ice plate is falling down from the evaporator, the magnetic switch is activated for a while providing the signal to the PC Board to restart a new freezing cycle.

5. Observe first ice cube harvest and check size of ice cubes; if an adjustment is required thread down or out screw NO.1 as shown on below illustration.

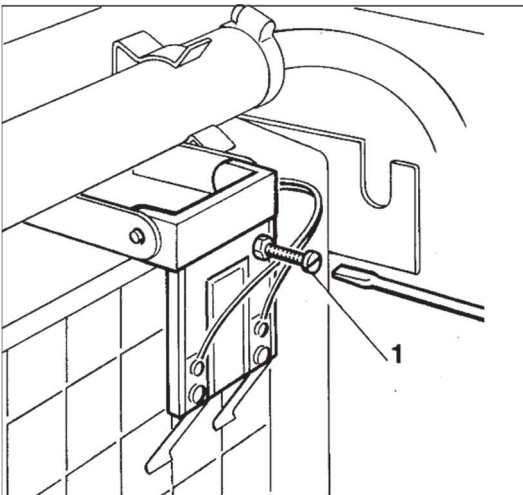

This screw position determines the distance between the sensor reeds and the egg-crate evaporator thus keeping the ice cube at a proper thickness.

NOTE: This type of machine produce an "ICE PLATE" that breaks when falls down into the storage bin. Setting the ice thickness sensor in order to have single ice cubes may cause malfunction of the machine.

6. Observe second and third cube harvest. Check if size and shape combination is correct. In areas where extreme problem water conditions exist, filtering or purifying equipment is recommended.

NOTE: If water used is too soft, "demineralized" the ice thickness sensor might not be able to sense the water on its reeds, thereby it will not switch the unit on harvest cycle. A safety system built in the P.C. Board switches the unit on harvest cycle whenever the freezing period gets longer than 30' or 40'.

NOTE: To assure a correct operation of the machine the water must have a minimum electric conductivity of 20µs.

7. Check operation of magnetic switch controlling it by keeping open the bottom end of plastic deflector for more than 30 seconds. The machine must switch off at storage bin full. Release the plastic deflector. The machine should restart in the freezing cycle mode within few seconds going through a 3' delay time.

8. Place again all cabinet panels and screws previously removed.

9. Thoroughly explain to owner/user the significant specifications of the ice maker startup, reset and operation, going through the procedures in the operating instructions. Answer all questions about the ice maker by the owner and inform the owner himself of the name and telephone number of the authorized service agency serving him.

OPERATION

FREEZE CYCLE

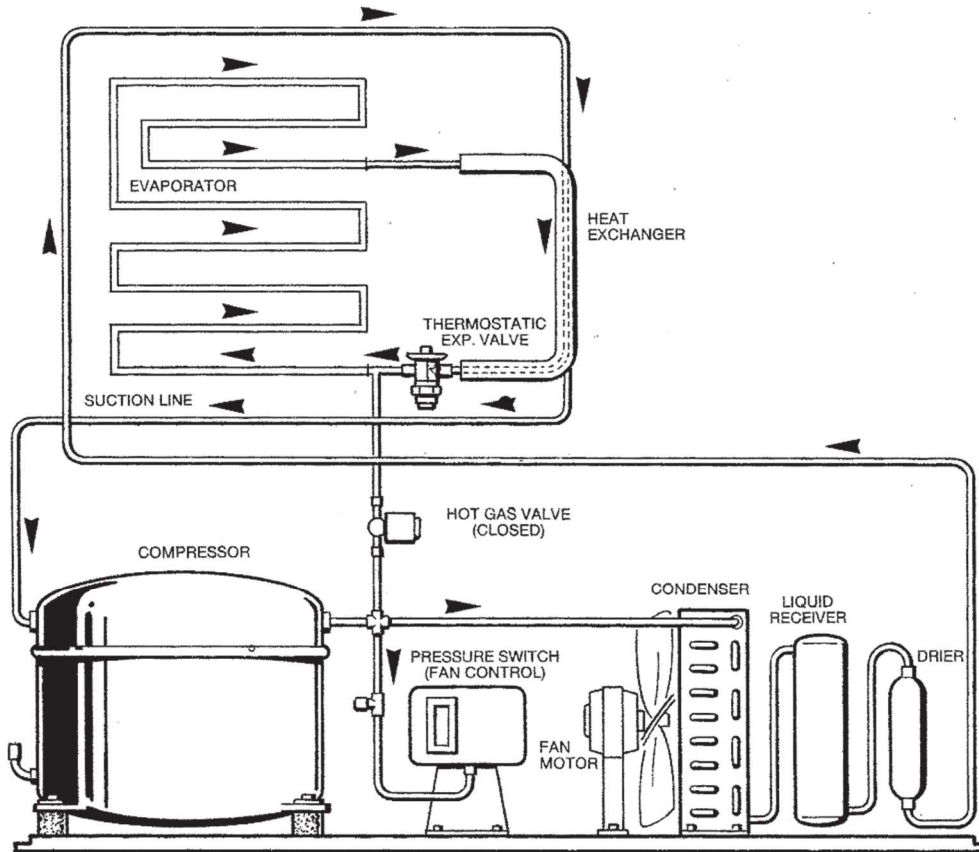

REFRIGERATION SYSTEM SCHEMATIC

REFRIGERATION DURING FREEZE:

This ice machine employs either air or water as a condensing media, the refrigeration system for either one is as follows:

At the hermetic compressor, Refrigerant is compressed into a high temperature, high pressure gas.

The gas moves through the discharge line into the condenser, air or water-cooled. If air-cooled, the discharge pressure will change with the heat load and the ambient air temperature. If water-cooled, the discharge pressure is controlled by the amount of water flowing through the condenser - which is determined by the water regulating valve.

After the gas is cooled in the condenser, giving up much of its heat, the gas condenses into a high pressure liquid. This liquid travels through the liquid line to the metering device, a thermostatic expansion valve.

The thermostatic expansion valve meters how much liquid refrigerant is to be allowed into the evaporator section of the refrigeration system.

This is determined by the temperature of the TXV sensing bulb, located on the suction line manifold, at the outlet of the evaporator.

If the bulb senses a warm suction line, more refrigerant is allowed into the evaporator, (common at the beginning of the freeze cycle) and when the temperature begins to fall, less refrigerant is allowed through.

This is why the suction side gauge pressure will decline throughout the freeze cycle. At the evaporator, the liquid refrigerant released from high pressure, boils off in the low pressure environment and absorbs heat, thus cooling the evaporator surface and anything near it, such as water.

The low pressure refrigerant vapor then is forced through the heat exchanger where any excess liquid refrigerant boils-off, allowing only refrigerant vapor to enter the compressor suction tube, where it is recompressed into high pressure, high temperature gas again and the cycle repeats.

FREEZE CYCLE

WATER SYSTEM

A combination of a solenoid water inlet valve with a water level sensor is used to control the level of the water into the reservoir or sump. A pump, running continuously, after the first 40" of freezing cycle, forces the water to the top of the evaporator, where it is distributed through a water tube and then cascades down

the evaporator surface by gravity. As it flows across the refrigerated evaporator, some of the water will be chilled enough to change form, turn to ice, and stay frozen onto the evaporator cells. Most of the water returns to the reservoir, to be sucked back into the pump, and re-pumped over the evaporator.

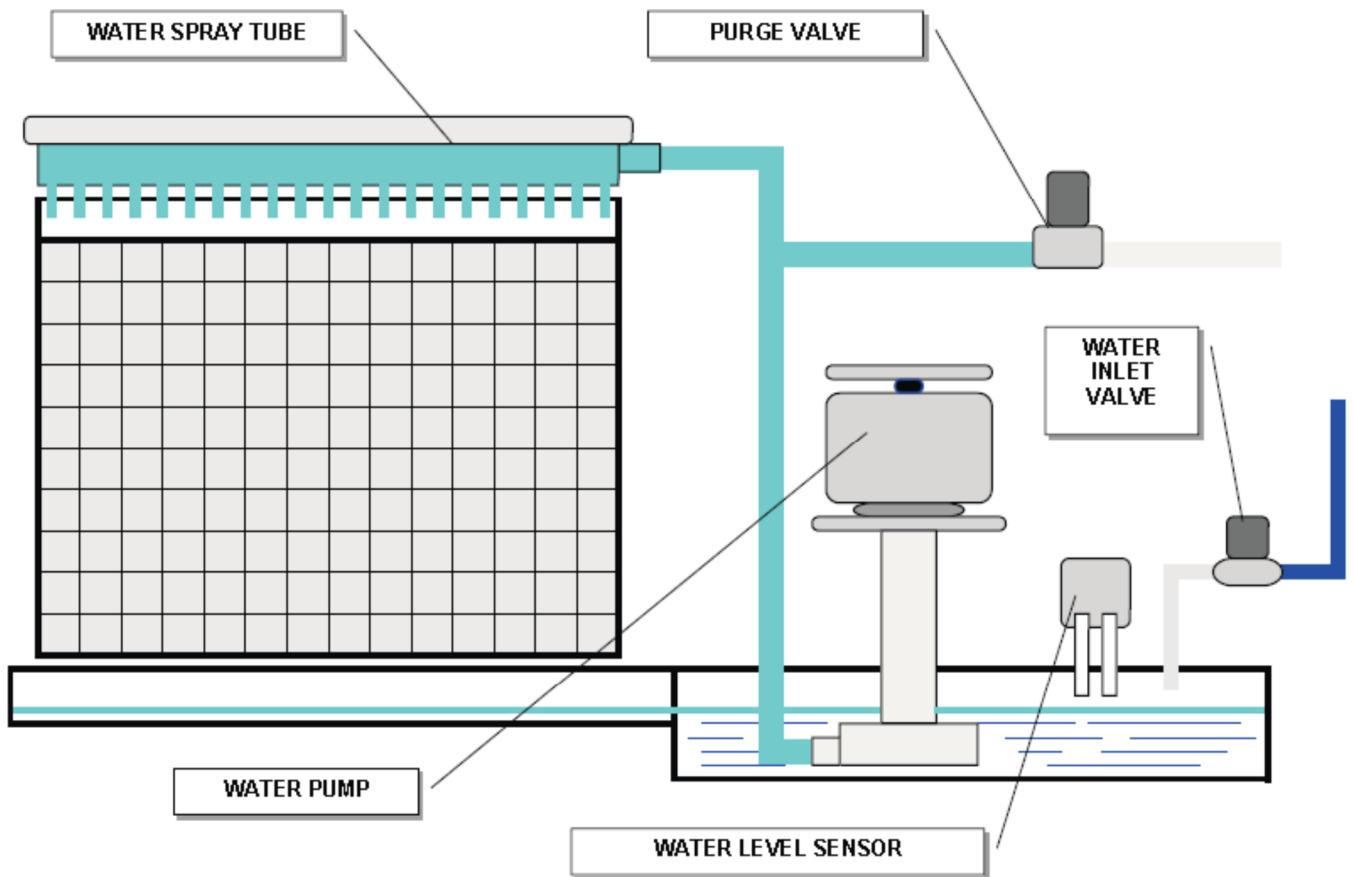

HARVEST CYCLE

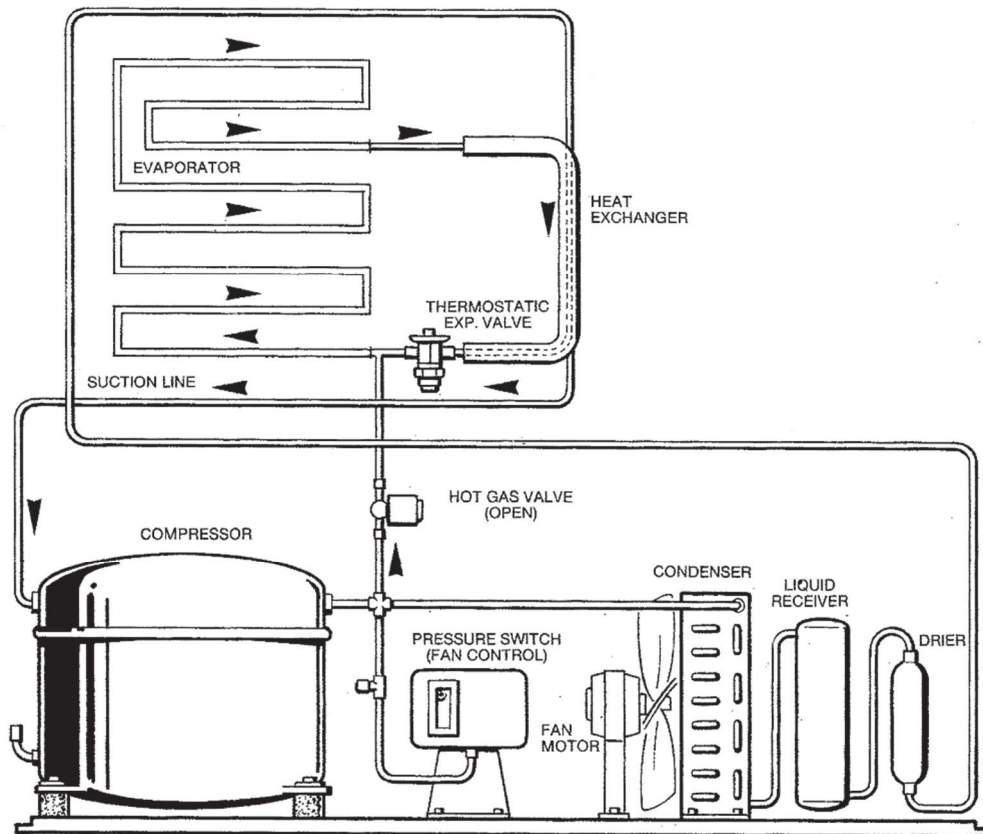

REFRIGERATION SYSTEM SCHEMATIC

REFRIGERATION SYSTEM DURING HARVEST

The refrigeration system performs the harvest of ice by use of a hot gas bypass valve. When the time comes to de-ice the evaporators, the harvest valve is energized, and the high temperature, high pressure gas bypasses the condenser, and is allowed directly into the evaporator. The high pressure gas is cooled by the cold evaporator so it condenses into a liquid, giving up its heat as it does so. This heat warms the evaporator and the ice frozen onto the evaporator surface melts, releasing the frozen cubes. Ice then falls by gravity into the storage bin.

The liquid refrigerant goes through the suction line into the heat exchanger where it boils-off so that only refrigerant vapor is drawn into the suction tube of the compressor.

WATER SYSTEM

During the harvest cycle, the electric water drain valve is energized thereby opening the drain line.

All water remained in the reservoir at the end of freezing cycle is pumped-out, to the waste, through the water purge valve and drain line, eliminating any possible build-up and accumulation of minerals concentration and impurities in the water reservoir. (According DIP Switch #6 setup)

20" after the Purge Valve open, the Water Inlet Solenoid Valve is energized for 10 seconds only in order to have a short flush of fresh water into the sump while the Water Pump and Purge valve are still in operation

When the released ice cubes drop into the bin, they open-up for a fraction of a seconds the bottom end of plastic deflector.

This deflector swinging motion is enough to reset the contact of the magnetic switch which - via PC board de-energizes the water drain valve allowing the unit to initiate a new freezing cycle. The harvest cycle lasts about 1.5-2 minutes.

CONTROL SEQUENCE

At the start of the freezing cycle, the contacts of the magnetic switch mechanically operated

by the actuator plate of the deflector cover are closed, thereby - via PC board - closing the circuit to the main contactor coil and consequently to the compressor and fan motors and 40" later, to the water pump motors.

Then, as the ice thickness reaches the value that corresponds to the full cube size, the film of water that constantly cascades over the slab of ice formed on the evaporator, arrives to establish a contact between the two fingers (energized at low voltage) of the ice sensor control, located on the front upper right side of the evaporator. If the contact between the two fingers of the ice sensor remains established - by the film of water - for more than 6 seconds, a small relay of the PC board, get energized, controlling -simultaneously both the harvest valve and the water drain valve.

NOTE: in case of failure of ice level sensor, the PC Board turns - on automatically the unit into the defrost cycle when the freezing cycle reaches 30 or 40 minutes according to the operation of the fan motor during the freezing cycle.

At this point, the unit initiates the defrost cycle. The hot gas circulating into the evaporator serpentine causes a slight melting of ice cubes which get released from their molds. Once entirely released the ice cubes drop simultaneously into the ice storage bin below; by doing so they move apart from the evaporator bottom end the plastic deflector. This plastic deflector has on its side a magnetic switch that on account of the deflector swinging motion, caused by the ice while dropping in the bin, opens and closes their contacts. This will, in turn, deactivates the relay contacts that controls the hot gas and water drain valve which get de-energized allowing the unit to start a new freezing cycle.

When the ice bin is full of ice, the last batch of ice cubes released from the evaporator accumulates to keep the bottom end of the plastic deflector in open position; with the magnetic switch contacts open for longer than 30" the entire unit stops with the glowing of the BIN FULL LED.

The machine will restart when the ice deflector will be back in its normal vertical position provided that 3' are elapsed from unit stop. If not the machine will delay its restart till 3' are

elapsed with the blinking of the BIN FULL LED.

ALARM CONDITIONS

Both the last two red LED are on steady:

Condenser Sensor out of order.

Both the last two red LED are blinking slow:

Water error.

Water level inside the water sump too slow after 3' or 6' from the activation of the Water Inlet Valve, according DIP Switch #4..

Both the last two red LED are blinking fast:

Water error recovery.

Every 30 minutes, Water inlet Solenoid Valve will open 180 seconds for recharge water after the tripping OFF on water error, If water full, the machine automatic reset.

Reset mode:

And press MODE button can go to start up cycle.



The fourth red LED is on steady:

3 times too long Harvest Cycle time

(according DIP Switch #3 setup),

The fourth red LED is blinking slow:

Too Hi condensing temperature error.

The condenser sensor detected a temperature >70°C.

For the first 2 times, machine will automatic reset when temperature drop down. and the machine will stop when high temperature occurs the third time, ice machine will stop,

Reset mode:

And press MODE button can go to start up cycle.

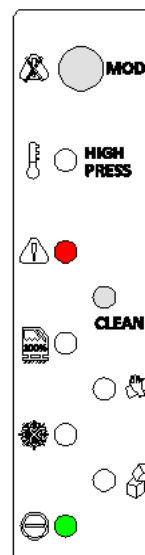

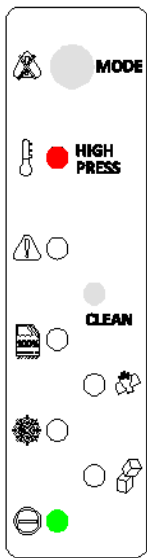

The fifth red LED is on steady:
Too High discharge pressure,
 higher than 33 bar (460 PSI)
 For the first 2 times, machine will
 automatic reset when pressure
 drop down. and the machine will
 stop when high temperature occurs
 the third time, ice machine will stop,
Reset mode:
 And press MODE button can go to
 start up cycle.

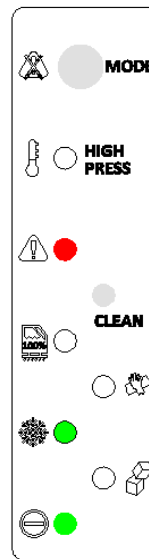

Both the fourth red LED and second
 green LED are blinking fast:
**5 times too long Freeze Cycle
 time**
Reset mode:
 And press MODE button can go to
 start up cycle.



Both the third yellow LED and forth
 red LED are blinking fast:
Ice thickness sensor fault
 When machine start, if PC board
 detect the ice thickness ON,
 machine will stop.
Reset mode:
 And press MODE button can go to
 start up cycle.

PC BOARD SET UP

The PC Board can be set up for:

MANUAL RESET MODE

To Restart the machine it is necessary to Push the MODE Button

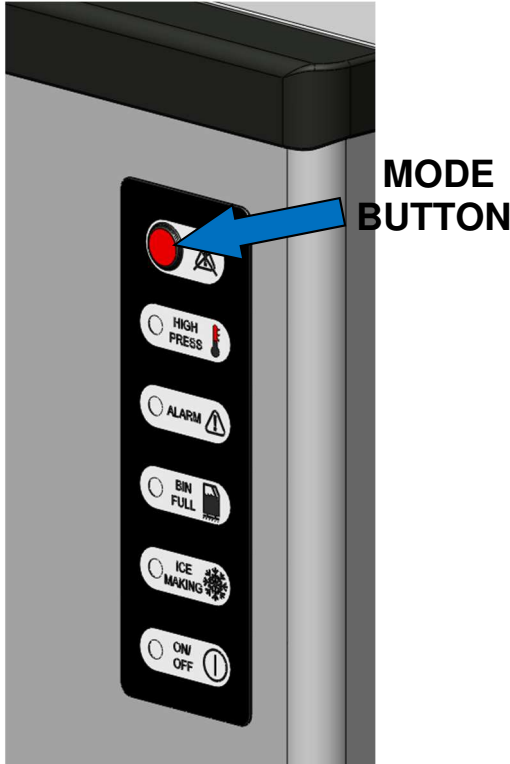

DIP SWITCH SETUP

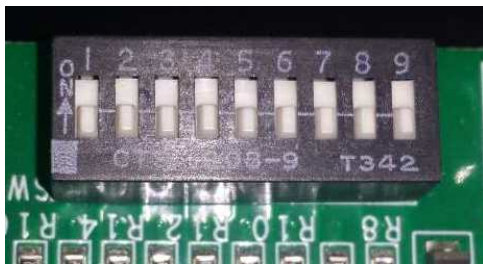

- #1 OFF For NW series
ON For NU modes
- #2 OFF No time delay
ON Have 90' delay
(For NW1008 only)
- #3 OFF 3.5' Harvest time
ON 6' Harvest time
- #4 OFF 3.5' Water fill time
ON 6' Water fill time

- #5 OFF Fill water in first 4' in freezing cycle
ON IF fan motor in always in operation, fill water in first 3', if fan motor in on-off state, ① temperature of condenser sensor is less than 38°C during harvest cycle, fill water in first 4', ②if temperature of condenser sensor is more than 38°C, fill water in first 5', fill water again after 3' from second fill during freezing cycle (For NW1408 only)

- #6 Water purge control
- #6-OFF/#7-OFF Water pump work 30"
- #6-ON/#7-OFF Water pump work 6" and 30" every sixth cycle.
- #6-OFF/#7-ON Water pump work 30" every three cycles.
- #6-ON/#7-ON Water pump work 30" every six cycles

#8 ON For water temperature sensor use (only for NU Serials)

- #9 OFF Machine will stop after clean procedure, need to press clean button to restart
- ON Machine will restart after clean procedure

Default Factory Setting - All Dip Switches OFF

MODE BUTTON FUNCTION

Press MODE button can restart machine when machine in alarm.

When machine is working, press MODE button will going to next process as follow:
Start -- Automatic clean -- Pressure balance -- Freezing -- Harvest -- Bin full

NOTE: There is same function MODE and CLEAN button in PC board and indicate board.

IMPORTANT: All PC board setup should be operated by authorized professional.

DIP SWITCH FACTORY SETTING COMBINATIONS PER MODEL AND VERSION									
		PREHEAT	DEFR.CYCLE ADD TIME	WATER TIME	ADD WATER	DRAIN TIME		WATER TEMP. SENSOR	CLEAN SETTING
DIP SWITCH	1	2	3	4	5	6	7	8	9
NU	ON	OFF	OFF	OFF	OFF	OFF	OFF	ON	OFF
NW307/308	OFF	OFF	OFF	OFF	OFF	OFF	OFF	OFF	OFF
NW507/508	OFF	OFF	OFF	OFF	OFF	OFF	OFF	OFF	OFF
NW457/458	OFF	OFF	OFF	OFF	OFF	OFF	OFF	OFF	OFF
NW608	OFF	OFF	OFF	OFF	OFF	OFF	OFF	OFF	OFF
NW1008	OFF	ON	OFF	OFF	OFF	OFF	OFF	OFF	OFF
NW1408	OFF	ON	OFF	OFF	ON	OFF	OFF	OFF	OFF

DIP n.	SETTING	MEANINGS
#1	OFF	NW MODE
	ON	NU MODE
#2	OFF	No time delay
	ON	Have 90'delay
#3	OFF	3.5' Harvest time
	ON	6' Harvest time
#4	OFF	3.5' Water fill time
	ON	6' Water fill time
#5	OFF	Refill water one time
	ON	refill water two time
#6	OFF	Water pump works for 30 seconds
#7	OFF	
#6	ON	Water pump worksfor 6 seconds for five harvesting and the sixth 30 seconds
#7	OFF	
#6	OFF	Water pump works for 30 seconds every three harvest cycles
#7	ON	
#6	ON	Water pump works for 30 seconds every six cycles.
#7	ON	
#8	OFF	No water temperature sensor
	ON	For water temperature sensor use
#9	OFF	Machine will stop after clean procedure, need to press clean button to restart
	ON	Machine will restart after clean procedure

SERVICE SPECIFICATION

In servicing a machine, it is often useful to compare that individual unit operating characteristics to those of a normally operating machine. The data that follows gives those characteristics; however, be aware that these values are for new, clean machine operating at 21 °C ambient and 15 °C water. Use these numbers as a guideline only.

COMPONENT

Reservoir Level

NW307/308	65~69mm
NW507/508	85~90mm
NW 457/458/NW608	80~85 mm
NW 1008	100~105 mm
NW1408	100~105 mm

Cube Size Control Ice Sensor –
distance from evaporator 3~5 mm

Refrigerant charge R 404A

MODEL	NW308	NW508	NW 458	NW 608	NW1008 380V	NW1008 220V	NW1408 220V
Air cooled 50 Hz	460	730	700	850	1600	1350	2200
Air cooled 60 Hz	460	500	700	850	-----	1300	2200
Water cooled 50 Hz	330	500	500	550	1300	1200	1800
Water cooled 60 Hz	300	500	500	550	-----	1200	1800

Refrigerant charge R452A

MODEL	NW308	NW508	NW 458	NW 608	NW1008 380V	NW1008 220V	NW1408 220V
Air cooled 50 Hz	550	800	700	950	1600	1350	2200
Air cooled 60 Hz	-----	-----	-----	-----	-----	-----	-----
Water cooled 50 Hz	350	500	500	550	1350	1200	1800
Water cooled 60 Hz	-----	-----	-----	-----	-----	-----	-----

Refrigerant charge R290

MODEL	NW307	NW507	NW 457				
Air cooled 50 Hz	149	149	149				

NOTE: Always check nameplate on individual ice machine for special refrigerant charge before charging the refrigeration system. Such refrigerant charge is the average charge for the NW Modular Cubers. However it is important to check nameplate of each machine.

High Pressure Safety Switch.

NW307-308-507-508-457-458-608-1008-1408:

Cut in 23 bar

Cut out 33 bar

OPERATING CHARACTERISTICS

On air-cooled models during the freezing cycle, the discharge pressure is maintained between two preset values by means of fan control (condenser sensor); and at the same time, the suction pressure will also decline reaching its lowest point just before harvest. Compressor amps experience a similar drop.

On water-cooled, the discharge pressure is constantly, maintained during the freeze cycle by the water regulating valve. However, suction pressure and compressor amps, will still decline as the machine freezes ice.

Refrigerant metering device

Thermostatic expansion valve.

COMPONENT DESCRIPTION

1. Front Console Panel

A		BUTTONA Reset/Washing
1		LEDNo.1 Alarm high pressure
2		LEDNo.2 Alarm
3		LEDNo.3 Bin full.
4		LEDNo.4 Operation
5		LEDNo.5 Electrical power supply

NW SERIES

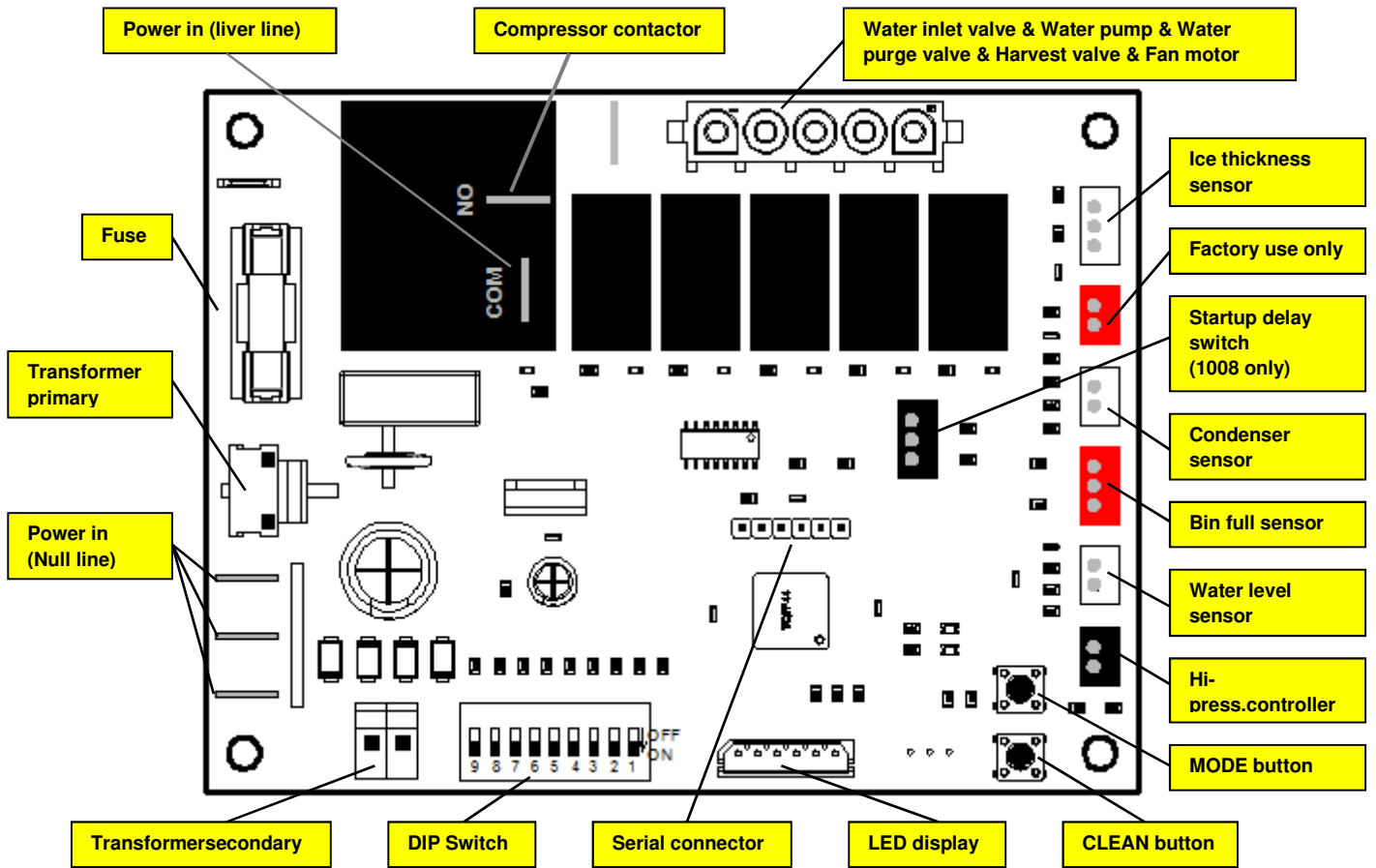

2. P.C. Board (As above picture)

Located in the control box, this board is the brain of the system as it governs the ice machine cyclematic through sensors, relays and switches. It consists of two separated printed circuits one at high and the other at low

voltage integrated with a fuse, of seven connectors for the sensors/switches (as above picture), of one outlet connector (front LED display), of one serial port connector, of two 2-PIN plug for transformer input and output power, of two terminals for input power live line and compressor output, of 3 terminals for power null

line, of one 5-PIN plug for components output, and two buttons for MODE and clean, and one DIP Switch for PC board setup.

3. Compressor Contactor

Located in the control box, the compressor contactor functions to carry the compressor line current. The contactor is wired to receive power from the P.C. Board.

4. Ice Thickness Sensor

Located in the front upper right side off the evaporator, the sensor is made with two metal reeds in which passes power at low voltage. The two metal reeds, which are individually insulated, are set through a setting screw, to maintain a minimum clearance from the evaporator (3~5 mm). Once ice is formed into each mold and is thick enough to fill-up that minimum clearance existing between the two sensor reeds and the evaporator, the water that cascades over the ice has gradually approached to make contact between the two sensor reeds.

It is enough that this contact remains there for about 10 seconds that the P.C. Board receives the signals to put the ice machine on defrost.

5. Magnetic Switch

Located in the front of the evaporator plastic curtain, this switch sends a pulse to the P.C. Board which switches the machine back in the freezing cycle.

6. Hot Gas Solenoid Valve

The Hot Gas Solenoid Valve functions only during the Harvest Cycle, to divert the hot discharge gas from the Compressor, bypassing the Condenser and thermostatic expansion valve, for direct flow to the Evaporator Plate Assembly to release ice cubes from the ice cube molds.

The Harvest Solenoid Valve is comprised of two parts, the Body & Plunger and the Coil assemblies.

Installed in the discharge line of the Compressor, the energized solenoid coil lifts the valve stem within the valve body to cause the hot discharge gas to be diverted when the ice Thickness sensor has signaled to the P.C. Board to start the Harvest Cycle.

7. Condenser temperature sensor

The condenser temperature sensor probe (located in contact with the condenser tube coil) detects the condenser temperature variations and signals them by supplying current, at low voltage, to the P.C. BOARD.

In the air cooled versions, in relation to the different current received, the micro processor of the P.C. BOARD supplies, through a TRIAC, the power at high voltage to the fan motor so to cool the condenser and to reduce its temperature.

In case the condenser temperature rises and reaches 70°C (158F) the current arriving to the micro processor is such to cause an immediate stop of the machine operation with the blinking of the Red LED, and first two time machine will automatic restart, the machine will total stop when high temperature occurs the third time, And press MODE button can go to start up cycle.

8. High Pressure Control

The high Pressure Control, a safety control, is factory set to cut-out, at 33bar and cut-in at 22 bar. The control, functions as a precautionary device to shut OFF electrical power to Icemaker, should a loss of water occur to the water cooled Condenser or a burnt out of the fan motor on air cooled versions. The high Pressure Control is manual reset with reset button located on the rear side of the machine and a monitoring light on the Front Console Panel.

9. Water Regulating Valve

(Water Cooled Models)

The Water Regulating Valve functions maintain a constant Compressor head pressure, by regulating the amount of incoming water flow through the Condenser, on water-cooled models. The valve operates through the refrigerant system high side pressure. Rotating the adjusting screw located on top of the valve, can INCREASE or DECREASE the water flow through the water- cooled Condenser, which in turn, will DECREASE or INCREASE the Compressor operating head pressure.

10. Water Distribution System

The Water Distribution System functions to even supply water to all cells of the evaporator

plate. The water pump pumps water from the sump to the tee. From there water is channeled through the vertical PVC tube to the water distributors, above the evaporator plate, and from the holes in the distributor tube water flows to the cells on one side of the evaporator plate. Gravity flow returns the unfrozen excess portion of water to the sump reservoir for recirculation.

11. Water Purge Solenoid Valve

The Water Outlet Solenoid Valve functions in conjunction with the water pump to flush-out the sump assembly as DIP switch #6 setup. This action cleans-up and rinses the sump during each harvest cycle preventing dangerous water minerals concentration.

12. Thermostatic Expansion Valve

The Thermostatic Expansion Valve regulates the flow of refrigerant to the evaporator and reduces pressure of liquid refrigerant from condensing pressure to evaporating pressure.

13. Water pump

The water pump primes the water from the sump to the water distributor tube and through the distributing holes it cascades down onto the evaporator cells by gravity so to be frozen into clear ice cubes. The water pump remains off during the first 40" seconds of the freezing cycle (to avoid any cavitations problem).while it's kept running during as DIP switch #6 setup.

14. Water inlet solenoid valve - 3/4" male fitting

The Water Inlet Solenoid valve is energized by the P.C. Board during the beginning of the freezing cycle till the water reaches the maximum level into the sump (controlled by the Water Level Sensor).

After 3 minutes, from the start up of the freezing cycle, the Water Inlet Valve is energized again for a short period to re-fill the sump with water till again to the maximum level so to minimize any possibility of slush ice formation

A flow control, fitted into its outlet port, reduces the pressure of the water flow.

15. Water level sensor

The Water Level Sensor, located on the upper right side of the water sump, works in conjunction with the P.C. Board in order to control the water level at beginning of the freezing cycle by receiving a low power current passing through the water. When the current reaches the PC Board, the water inlet solenoid valve is de-energized.

In case the PC Board doesn't receive any signal(current) as DIP switch #4 setup from the Water Level Sensor, the PC Board trips OFF the operation of the machine with the switching ON of the Water Error LEDs.

16. Start up delay PC Board by-pass switch

Located in the back side of the machine allows to by-pass the delay time controlled by the delay PC Board.

WARNING: It is IMPERATIVE to by-pass the delay time only when sure of proper warm up of compressor.

17. LED display

Located in the upper and right side of the machine when remove the front panel.

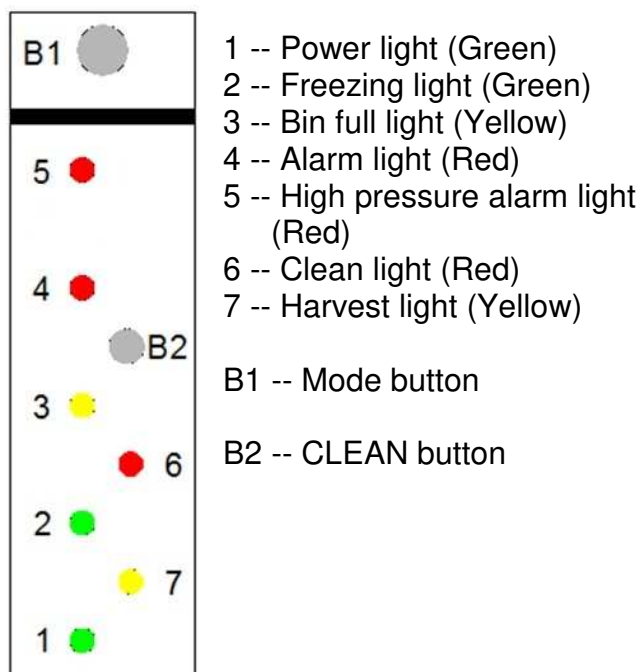

NW 308/508- WIRING DIAGRAM

220 V. 50 /60 Hz. 1 ph.

br = brown
 b = blue
 gy = yellow / green
 w = white
 bk= black

r = red
 o = orange
 p = purple
 g =green
 y =yellow

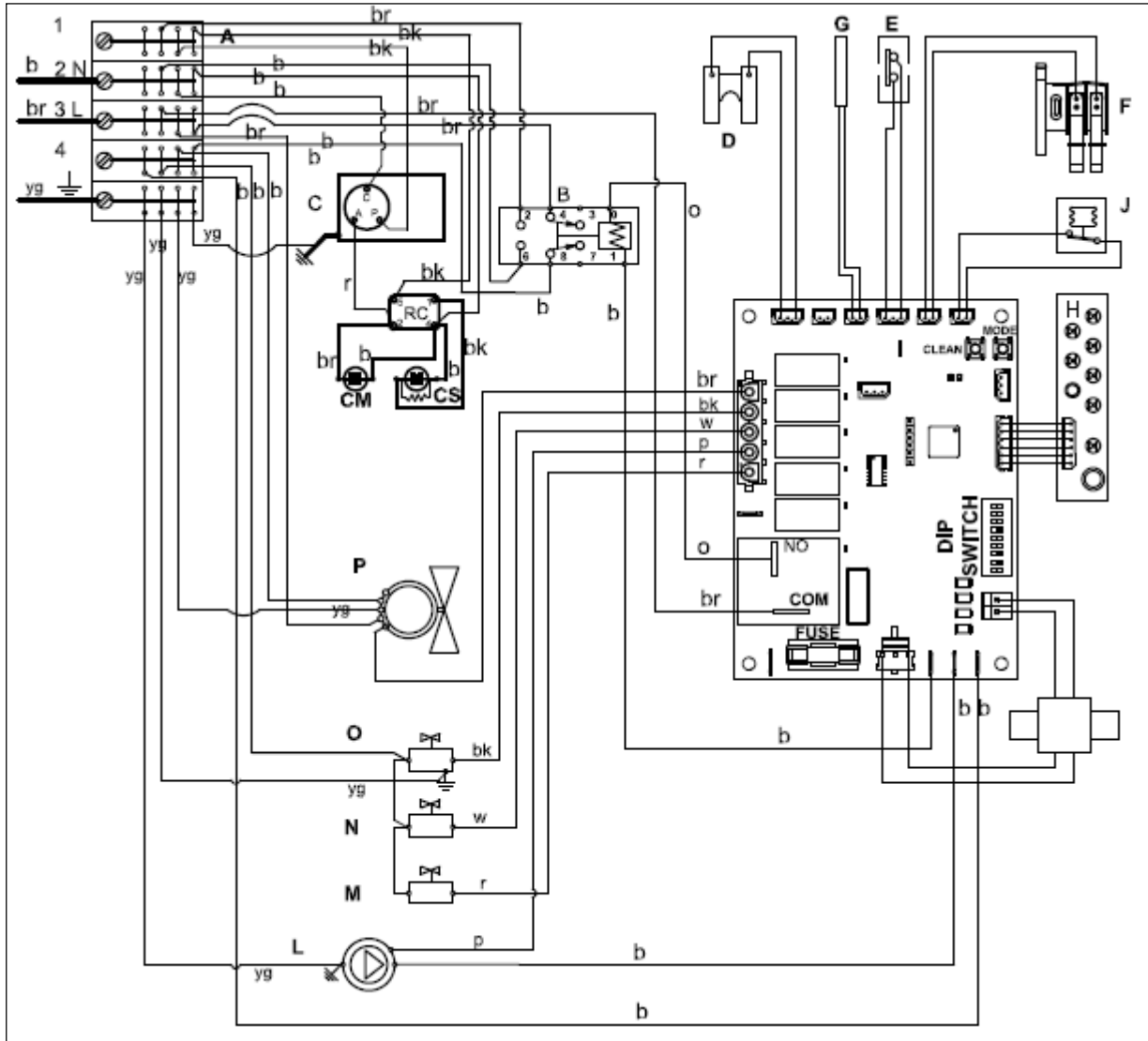

- A- TERMINAL BLOCK
- B- POWER RELAY
- C-COMPRESSOR
- D-ICE THICKNESS SENSOR
- E-ICE FULL SENSOR
- F-WATER LEVEL SENSOR
- G-CONDENSER SENSOR
- H-UIM BOARD

- I -PC BOARD
- J- MAX PRESSURE SWITCH
- L-WATER PUMP
- M-WATER INLET VALVE
- N-WATER PURGE VALVE
- O-DEFROST VALVE
- P-FAN MOTOR

(AIR COOLED ONLY)

NW 307/507/457- WIRING DIAGRAM

220 V. 50 Hz. 1 ph.

br = brown
 b = blue
 yg = yellow / green
 w = white
 bk = black

r = red
 o = orange
 p = purple
 g = green
 y = yellow

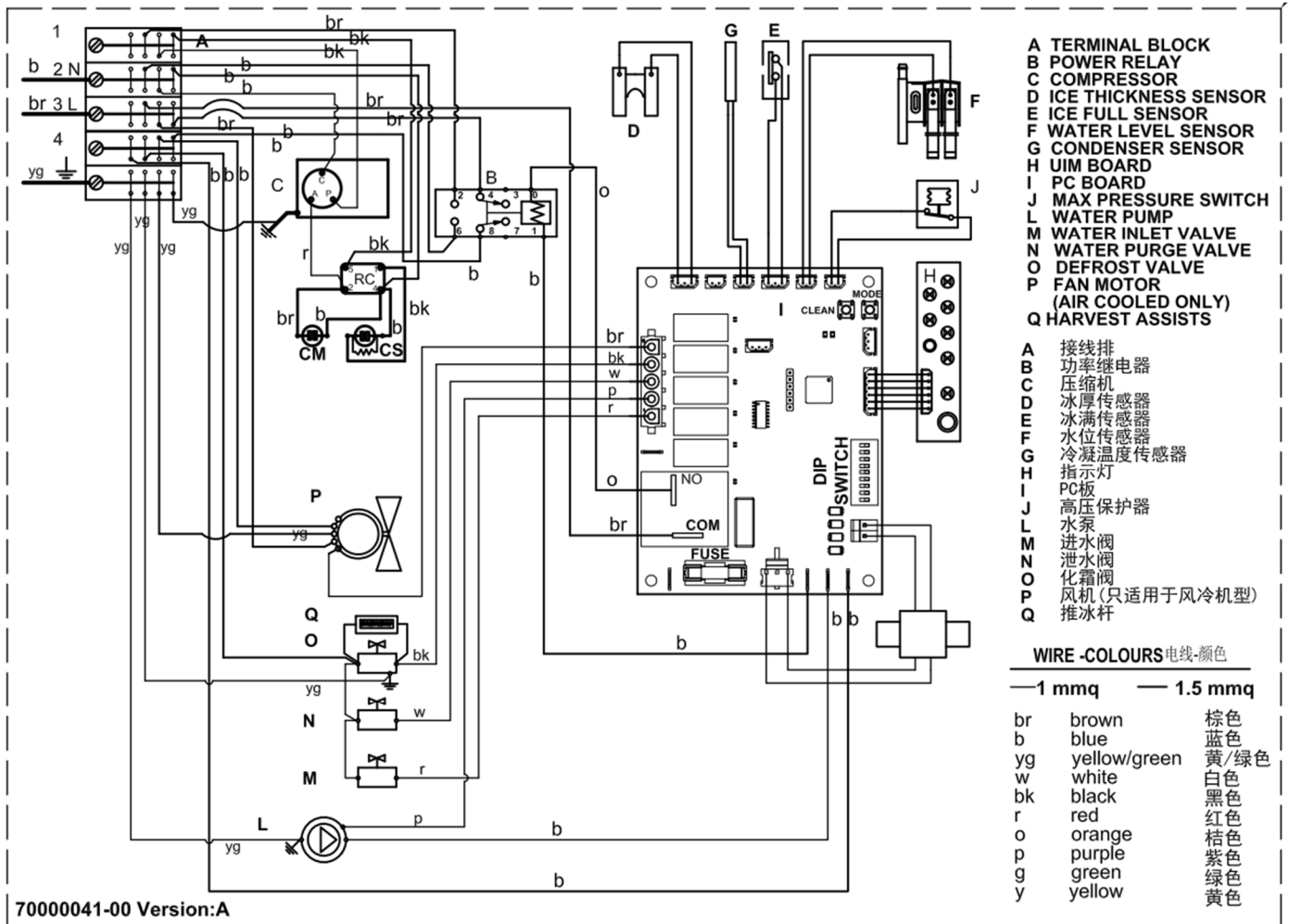

- A TERMINAL BLOCK
- B POWER RELAY
- C COMPRESSOR
- D ICE THICKNESS SENSOR
- E ICE FULL SENSOR
- F WATER LEVEL SENSOR
- G CONDENSER SENSOR
- H UIM BOARD
- I PC BOARD
- J MAX PRESSURE SWITCH
- L WATER PUMP
- M WATER INLET VALVE
- N WATER PURGE VALVE
- O DEFROST VALVE
- P FAN MOTOR
(AIR COOLED ONLY)
- Q HARVEST ASSISTS

- A 接线排
- B 功率继电器
- C 压缩机
- D 冰厚传感器
- E 冰满传感器
- F 水位传感器
- G 冷凝温度传感器
- H 指示灯
- I PC板
- J 高压保护器
- L 水泵
- M 进水阀
- N 泄水阀
- O 化霜阀
- P 风机(只适用于风冷机型)
- Q 推冰杆

WIRE-COLOURS 电线-颜色

—1 mmq	— 1.5 mmq
br brown	棕色
b blue	蓝色
yg yellow/green	黄/绿色
w white	白色
bk black	黑色
r red	红色
o orange	桔色
p purple	紫色
g green	绿色
y yellow	黄色

- A TERMINAL BLOCK
- B POWER RELAY
- C COMPRESSOR
- D ICE THICKNESS SENSOR
- E ICE FULL SENSOR
- F WATER LEVEL SENSOR
- G CONDENSER SENSOR
- H UIM BOARD
- I PC BOARD
- J MAX PRESSURE SWITCH
- L WATER PUMP
- M WATER INLET VALVE
- N WATER PURGE VALVE
- O DEFROST VALVE
- P FAN MOTOR
(AIR COOLED ONLY)
- Q HARVEST ASSISTS

NW 458/608- WIRING DIAGRAM

220 V. 50 /60 Hz. 1 ph.

m = brown
bc = blue
gv = yellow / green
b = white

n = black
r = red
a = orange
v = purple

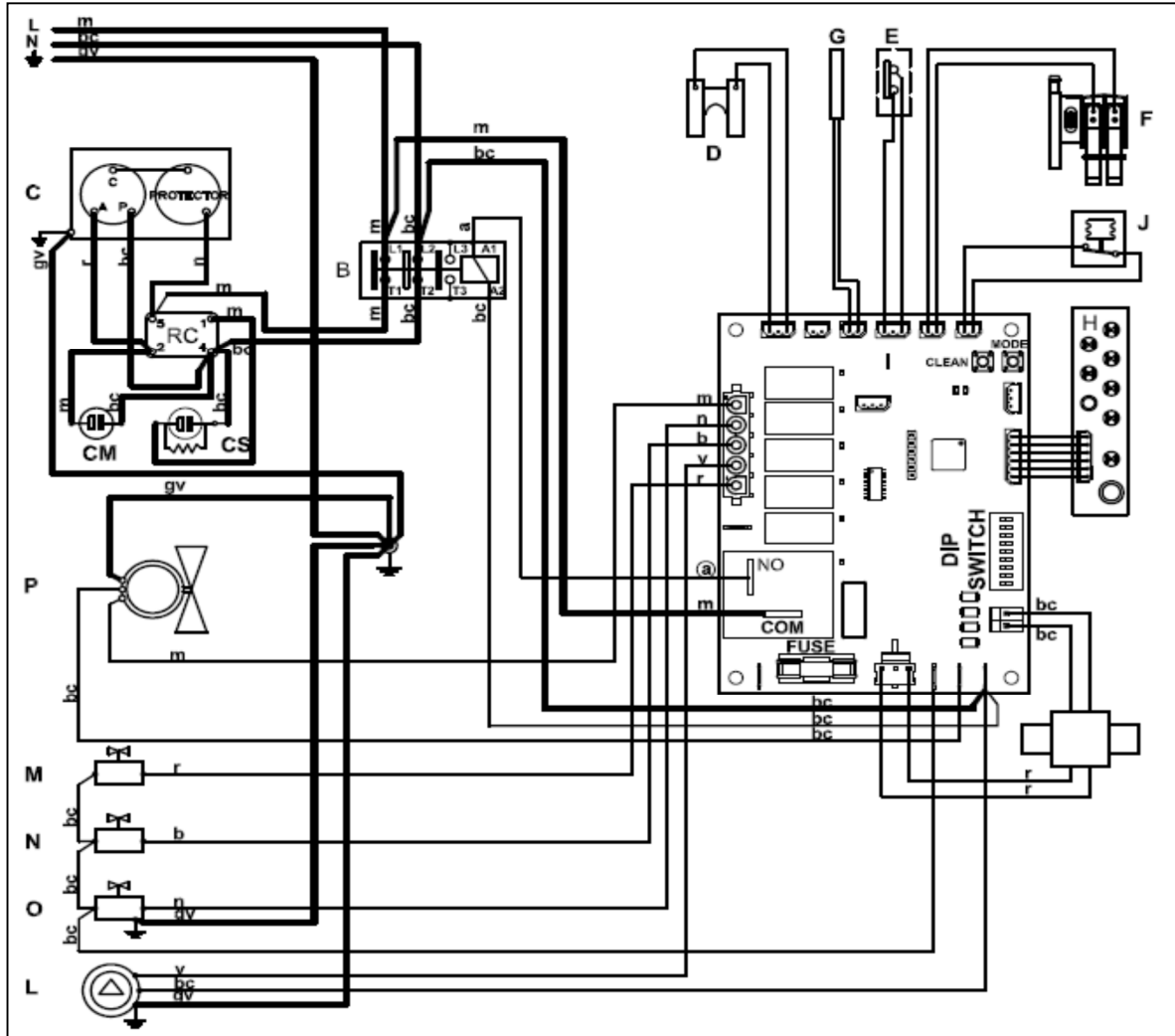

- B - Compressor contactor
- C - Compressor
- D - Ice thickness sensor
- E - Ice full sensor
- F - Water level sensor
- G - Condenser temperature probe
- H - Led display
- I - PC Board
- J - High pressure controller
- L - Water pump
- M - Water inlet valve
- N - Water purge valve
- O - Harvest valve

- P - Fan Motor (only AIR cooled unit)
- RC - Compressor relay
- CS - Start capacitor
- CM - Run capacitor

NW 1008 - WIRING DIAGRAM

220 V. 50 /60 Hz. 1 ph.

m = brown
bc = blue
gv = yellow / green
b = white
n = black

r = red
a = orange
v = purple
g = green
y = yellow

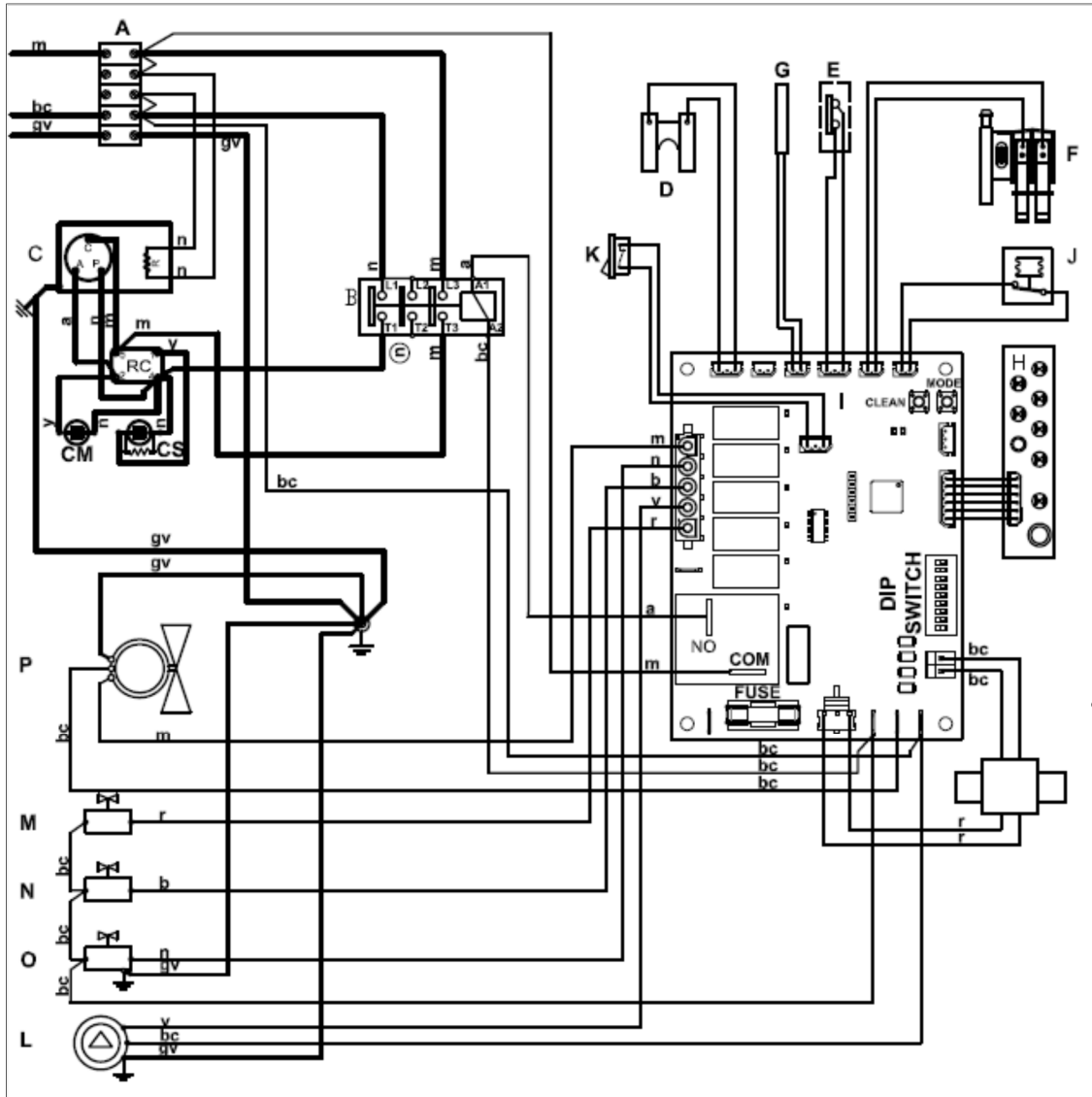

- | | |
|---------------------------------|--------------------------------------|
| A - Input terminal board | L - Water pump |
| B - Compressor contactor | M - Water inlet valve |
| C - Compressor | N - Water purge valve |
| D - Ice thickness sensor | O - Harvest valve |
| E - Ice full sensor | P - Fan Motor (only AIR cooled unit) |
| F - Water level sensor | R - Crankcase heater |
| G - Condenser temperature probe | RC - Compressor relay |
| H - Led display | CS - Start capacitor |
| I - PC Board | CM - Run capacitor |
| J - High pressure controller | |
| K - Startup delay switch | |

NW 1008 - WIRING DIAGRAM

380 V. 50 Hz. 3 ph.

m = brown
bc = blue
gv = yellow / green
b = white
n = black

r = red
a = orange
v = purple
g = green

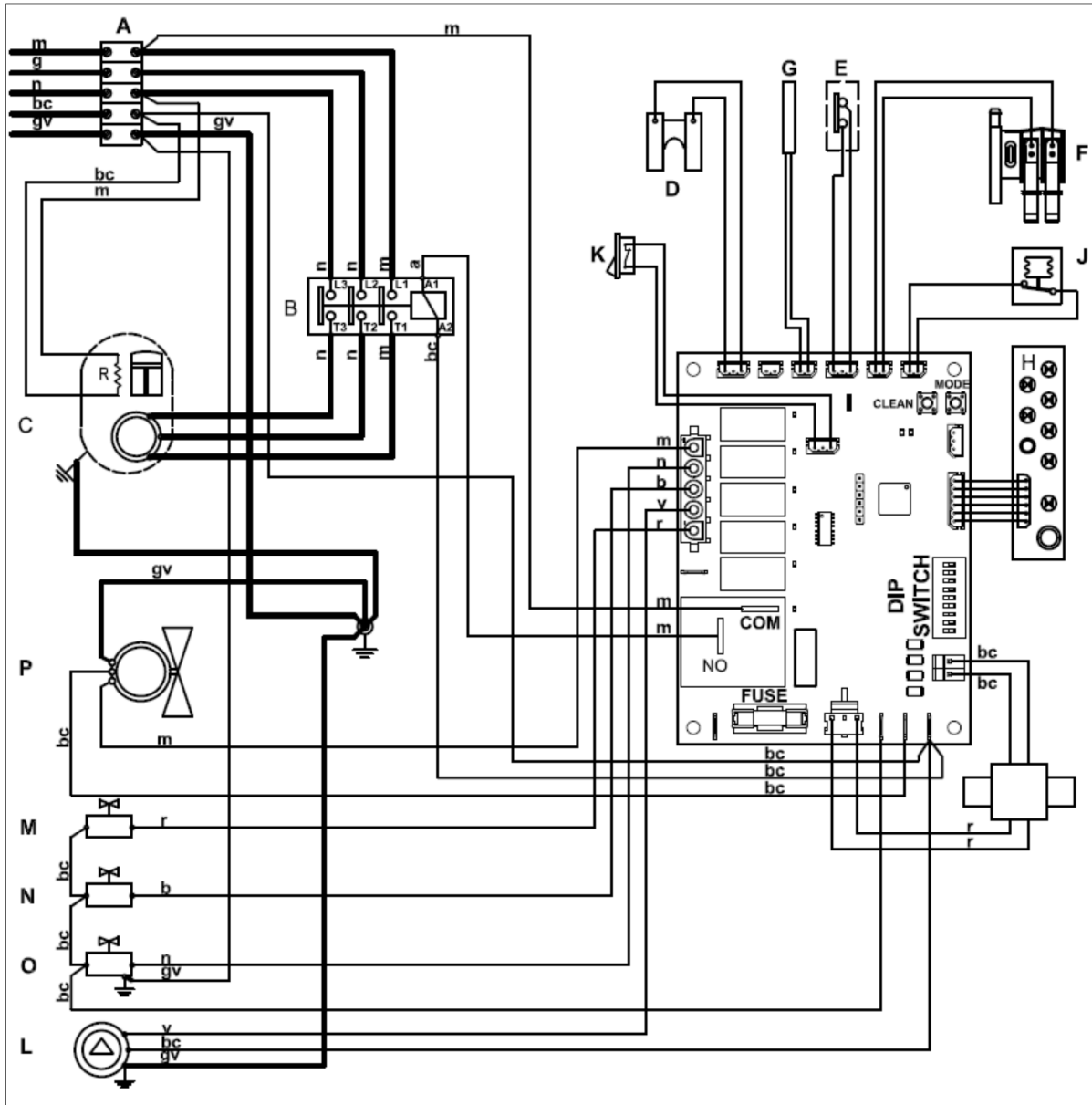

A - Input terminal board
B - Compressor contactor
C - Compressor
D - Ice thickness sensor
E - Ice full sensor
F - Water level sensor
G - Condenser temperature probe
H - Led display
I - PC Board

J - High pressure controller
K - Startup delay switch
L - Water pump
M - Water inlet valve
N - Water purge valve
O - Harvest valve
P - Fan Motor (only AIR cooled unit)
R - Crankcase heater

NW 1408 - WIRING DIAGRAM

220 V. 50 Hz. 1 ph.

m = brown
bc = blue
gv = yellow / green
b = white
n = black

r = red
a = orange
v = purple
g = green

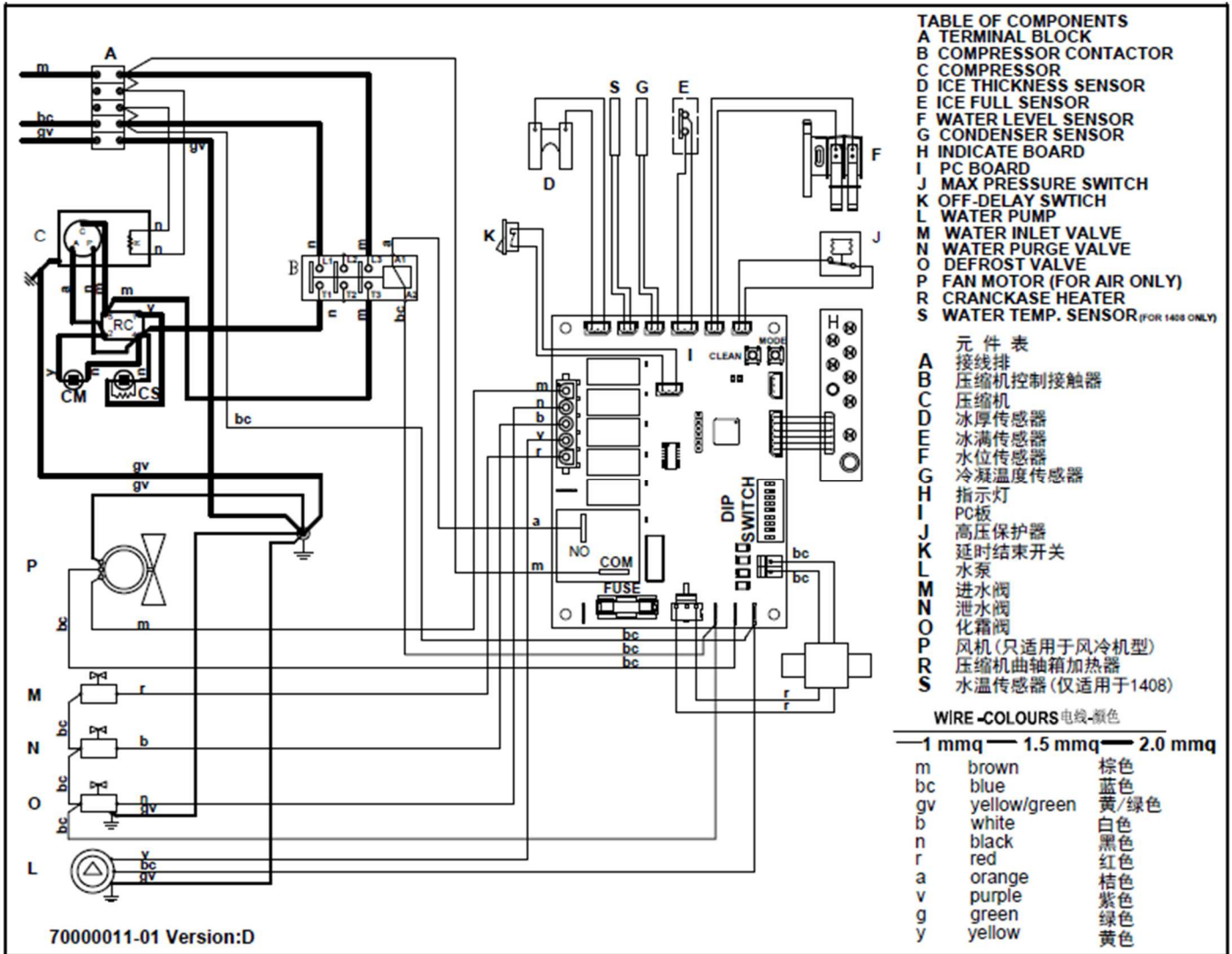

TABLE OF COMPONENTS

- A TERMINAL BLOCK
- B COMPRESSOR CONTACTOR
- C COMPRESSOR
- D ICE THICKNESS SENSOR
- E ICE FULL SENSOR
- F WATER LEVEL SENSOR
- G CONDENSER SENSOR
- H INDICATE BOARD
- I PC BOARD
- J MAX PRESSURE SWITCH
- K OFF-DELAY SWITCH
- L WATER PUMP
- M WATER INLET VALVE
- N WATER PURGE VALVE
- O DEFROST VALVE
- P FAN MOTOR (FOR AIR ONLY)
- R CRANKCASE HEATER
- S WATER TEMP. SENSOR (FOR 1408 ONLY)

元件表

- A 接线排
- B 压缩机控制接触器
- C 压缩机
- D 冰厚传感器
- E 冰满传感器
- F 水位传感器
- G 冷凝温度传感器
- H 指示灯
- I PC板
- J 高压保护器
- K 延时结束开关
- L 水泵
- M 进水阀
- N 泄水阀
- O 化霜阀
- P 风机 (只适用于风冷机型)
- R 压缩机曲轴箱加热器
- S 水温传感器 (仅适用于1408)

WIRE -COLOURS 电线-颜色

1 mmq	1.5 mmq	2.0 mmq
m	brown	棕色
bc	blue	蓝色
gv	yellow/green	黄/绿色
b	white	白色
n	black	黑色
r	red	红色
a	orange	桔色
v	purple	紫色
g	green	绿色
y	yellow	黄色

- A - Input terminal board
- B - Compressor contactor
- C - Compressor
- D - Ice thickness sensor
- E - Ice full sensor
- F - Water level sensor
- G - Condenser temperature probe
- H - Led display
- I - PC Board
- J - High pressure controller
- K - Startup delay switch
- L - Water pump
- M - Water inlet valve
- N - Water purge valve
- O - Harvest valve
- P - Fan Motor (only AIR cooled unit)
- R - Crankcase heater

SERVICE DIAGNOSIS



The table below is intended as a quick reference to aid the Service Agent in determining the cause of a particular type of malfunction, as well as the recommended repair. It is not intended to be an exclusive list.

Reference to other portions of this manual, including wiring diagrams, installation, and operation are recommended to better determine the cause of a problem.

SYMPTOM	POSSIBLE CAUSE	CORRECTION
Warning Red LED ON	See page 23-24	See page 23-24
No warning LED/LIGHT ON	P.C. Board inoperative. No power to unit.	Remove board and check. Check electrical source.
Bin full Yellow LED ON	Bin Full of ice.	None.
Machine runs, compressor does not.	P.C. Board compressor relay open. Compressor contactor open. Compressor relay open. Compressor winding open.	Test and replace. Test and replace. Test and replace. Test and replace.
Machine runs, makes ice, does not try to harvest.	Ice thickness control open. Too soft water. Built-in relay on P.C. Board open.	Check sensor fingers if are not covered with scale sediment. Water electrical conductivity must be higher then 20 μ s. Machine can't run with demineralized water. Check and replace P.C. Board.
Machine runs, makes and harvests ice but very slowly.	Low refrigerant charge.	Check system for correct refrigerant charge. Check for leak weight in charge.
Low ice capacity.	High discharge pressure due to not-condensable or overcharge. Inefficient compressor. Condenser dirty. Low water flow (Water-cooled). High air temperature (air-cooled).	Evacuate and weigh in charge. Replace. Clean. Check and repair. Check temperature of air entering condenser.
Machine makes irregular ice.	Plugged water distributor. TXV superheat wrong. Refrigerant charge low.	Clean water distributor. Adjust or replace. Adjust-check for leak. Recharge.

MAINTENANCE & CLEANING & SANITATION INSTRUCTIONS

A SCOTSMAN Ice System represents a sizable investment of time and money in any company's business. In order to receive the best return for that investment, in MUST receive periodic maintenance.

It is the USER'S RESPONSIBILITY to see that preferable, and less costly in the long run, to avoid possible down time by keeping it clean, adjusting it as needed and by replacing worn parts before they can cause failure. The following is a list of recommended maintenance that will help keep your machine running with a minimum of problems.

ICEMAKER

IMPORTANT:
THE FOLLOWING MAINTENANCE AND CLEAN SHOULD BE SCHEDULED AT LEAST TWO TIMES PER YEAR ON THIS ICEMAKER. CALL YOUR AUTHORIZED SCOTSMAN SERVICE AGENCY.

1. Check and clean or service any optional water treatment devices, if any installed.
2. Clean water strainer.
3. Check that the cabinet is level, in the side-to-side and front-to-back directions.
4. Clean/Sanitize the water system, evaporator plate and sump assembly, using a solution of Ice Machine Cleaner/Sanitizers. Refer to CLEANING - Icemaker.

NOTE:

Cleaning/Sanitizing requirements vary according to local water conditions and individual user operation.

Continuous check of the clarity of ice cubes and visual inspection of the water system parts, evaporator plates and the sump assembly before and after cleaning will indicate frequency and procedure to be followed in local areas.

5. Check and tighten all bolts and screws.

6. Check for water leaks and make corrections.

7. Check the bin control to test shut-off. Holding the evaporator deflector in open Position for more that 30", should cause the ice maker to shut-off.

Once the evaporator deflector is released in its closed position, the ice maker will restart.

8. Check cube size; adjust if required through setting screw of ice thickness control sensor.

9. With unit out of operation, clean the condenser using vacuum, cleaner, wisk broom or brush. Instruct customer to clean condenser frequently

DO NOT USE A WIRE BRUSH.

ICE STORAGE BIN

The interior liner of the bin is in contact with a food product, ice, and should be cleaned and sanitized regularly. Once a week sanitize it with a commercial food grade sanitizers complying with the manufacturer dilution.

CABINET EXTERIOR

Wipe clean unit and bin cabinet exterior with a clean cloth or disposable paper wipers, soaked in warm water with mild detergent solution.

CLEANING - ICEMAKER

WARNING - Ice Machine Cleaner contains Phosphoric and Hydroxyacetic acids. These compounds are corrosive and may cause burns. If swallowed, DO NOT induce vomiting. Give large amounts of water or milk. Call physician immediately. In case of external contact, flush with water. KEEP OUT OF THE REACH OF CHILDREN.

1. Empty bin of ice.

2. Remove front panel.

3. Wait till the end of the harvest cycle, switch off the machine, then switch ON again, push the CLEAN BUTTON on LED display for 2-3 seconds in one minute. The machine should go to clean/sanitize procedure, and the red CLEAN LED light on LED display will be fast blinking in whole procedure.

4. In beginning 30" of clean procedure, machine will purge water from sump, then pour on

- NW307/308 185 cc
- NW507/508 210 cc
- NW 457/458-608 250 cc
- NW1008 350 cc
- NW1408 350 cc

of Scotsman Ice Machine Cleaner directly into the reservoir while the water inlet valve will be energized till the fill up of the water sump. The water pump starts to operate.

5. After 10 minutes, machine will purge the clean Cleaner solution, and refill up the water sump, then go into automatic rinsing mode.

NOTE: RINSING mode consists of:

- a) Energize the water pump for 30".
- b) Energize the water drain valve and the water pump for 30".
- c) Energize the water inlet valve till the fill up of the water sump.

The above sequence is repeated 10 times so to be sure to have removed any possible trace of Ice Machine Cleaner.

6. At the end of the 10th Rinsing cycle, according DIP switch #9 setup, the machine:

#9 OFF machine stops the operation and blinking (slow) of the red Clean LED.

Push the CLEAN BUTTON when machine stop, the machine restarts in the freezing cycle

#9 ON Machine will go to freezing cycle directly.

7. Replace the evaporator cover deflector and front panel.

8. Check the next batch of cubes to be sure all the cleaner is gone (no sour taste).

CAUTION:
DO NOT use ice cubes produced from the cleaning solution. Be sure none remains in the bin.

9. Pour hot water into the storage bin melt the cubes, and to also clean the bin drain.

Scotsman[®]

Ice Systems

Scotsman Ice Systems (Shanghai) Co., Ltd.

Address:

Room 2505, Building 2, No 20 Xuhong
Middle Rd, Shanghai, China. 200235

Phone: 0086-21-61313200

Fax: 0086-21-61313330

Hotline: 0086-4006300076

E-Mail: sales@scotsman-china.com

Website: www.scotsman-china.com