

Read the operating instructions prior to commissioning

Operating instructions

## Deep-fat fryer

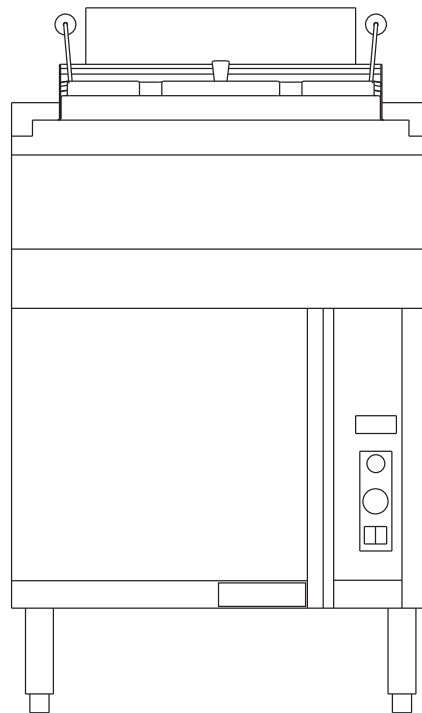

Translation from the original document • 2060301-20ABBE-- • 08/06/2017

Unit	Type of energy	Unit type	Model
Deep-fat fryer	Gas	Floor-standing unit	OPGFRIPG
		Countertop unit	SLGFRIPG

2060301-20ABBE--

en-GB

## Operating and display elements

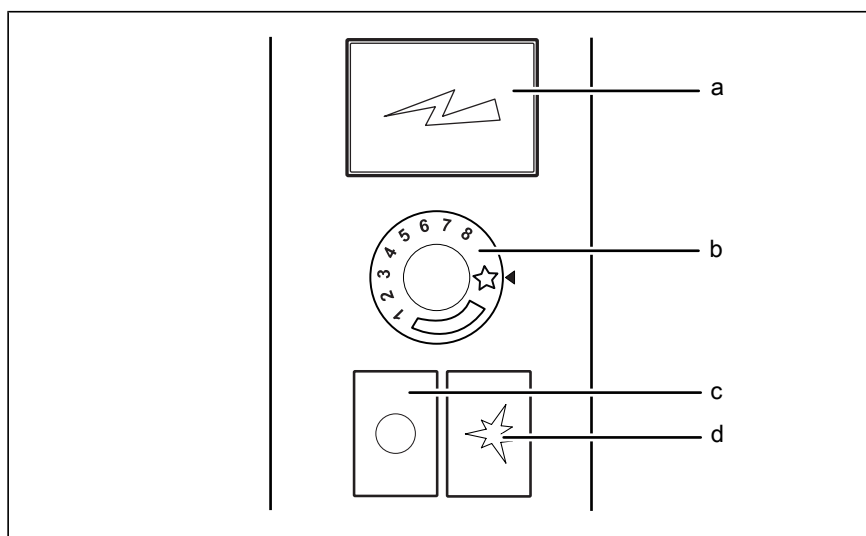

a Piezo pilot ignitor  
b *Temperature* control knob

c *Off* button  
d *Ignition On* button

**Manufacturer**

MKN Maschinenfabrik Kurt Neubauer GmbH & Co. KG  
Halberstädter Strasse 2a  
38300 Wolfenbüttel  
Germany

Phone +49 5331 89-0  
Fax +49 5331 89-280  
Internet [www.mkn.eu](http://www.mkn.eu)

**Copyright**

All rights to text, graphics and pictures in this documentation are held by MKN Maschinenfabrik Kurt Neubauer GmbH & Co. KG. Distribution or duplication is only permitted with the prior written consent of MKN.

Copyright by MKN Maschinenfabrik Kurt Neubauer GmbH & Co. KG.



<b>1 Introduction</b> .....	<b>7</b>
<b>1.1 About this manual</b> .....	<b>7</b>
1.1.1 Explanation of signs .....	8
<b>1.2 Intended use</b> .....	<b>9</b>
<b>1.3 Guarantee, warranty and liability</b> .....	<b>9</b>
<b>2 Safety information</b> .....	<b>10</b>
<b>3 Rules of conduct when the smell of gas is detected</b> ....	<b>13</b>
<b>4 Description of the unit</b> .....	<b>14</b>
<b>4.1 Overview of the unit</b> .....	<b>14</b>
4.1.1 Floor-standing unit .....	14
<b>4.2 Function of the operating and display elements</b> .....	<b>14</b>
<b>4.3 Fill quantities</b> .....	<b>14</b>
<b>4.4 Operating temperature</b> .....	<b>15</b>
4.4.1 Recommended cooking temperature and cooking time .....	15
<b>5 Operating the unit</b> .....	<b>16</b>
<b>5.1 Switching the unit on and off</b> .....	<b>16</b>
5.1.1 Switching on .....	16
5.1.2 Switching off .....	16
<b>5.2 Pausing and end of use</b> .....	<b>16</b>
5.2.1 Short pause .....	16
5.2.2 Longer pauses and end of use .....	16
<b>5.3 Handling deep-frying oil</b> .....	<b>17</b>
5.3.1 Ensuring that the oil is fit for human consumption .....	18
<b>5.4 Filling the deep-frying oil</b> .....	<b>19</b>
5.4.1 Gently heating up deep-frying oil .....	19
<b>5.5 Deep-frying</b> .....	<b>19</b>
<b>5.6 Emptying the deep-frying oil</b> .....	<b>20</b>
<b>6 Cleaning and caring for the unit</b> .....	<b>21</b>
<b>6.1 Preventing corrosion</b> .....	<b>21</b>
<b>6.2 Removing rust spots</b> .....	<b>21</b>
<b>6.3 Cleaning the housing</b> .....	<b>21</b>
<b>6.4 Cleaning the deep-frying basin</b> .....	<b>22</b>
<b>6.5 Cleaning the heating elements</b> .....	<b>22</b>
<b>6.6 Cleaning the drain</b> .....	<b>22</b>
<b>7 Troubleshooting</b> .....	<b>23</b>
<b>7.1 Cause of failure and the remedy</b> .....	<b>23</b>
<b>7.2 Nameplate</b> .....	<b>23</b>
<b>8 Carrying out maintenance</b> .....	<b>24</b>

<b>9 Disposing of the unit in an environmentally responsible manner .....</b>	<b>25</b>
<b>10 Manufacturer's declaration .....</b>	<b>26</b>



# 1 Introduction

## 1.1 About this manual

The operating instructions are part of the unit and contain information:

- On safe operation,
- On cleaning and care,
- On remedies in case of faults.

Be aware of the following notes and adhere to them:

- Read the operating instructions completely before operating the unit for the first time.
- Make the operating instructions available to the operator at all times at the operating site of the unit.
- Insert any supplements from the manufacturer.
- Keep the operating instructions throughout the service life of the unit.
- Pass on the operating instructions to any subsequent operator of the unit.

**Target group** The target group of the instruction manual is the operator, who is entrusted with the operation, cleaning and care of the unit.

**Figures** All figures in this manual are intended as examples. Discrepancies between these and the actual unit can arise.

## 1.1.1 Explanation of signs



**DANGER**  
**Imminent threat of danger**

Failure to comply will lead to death or very severe injuries.

---



**WARNING**  
**Possible threat of danger**

Failure to comply can lead to death or very severe injuries.

---



**CAUTION**  
**Dangerous situation**

Failure to comply can lead to slight or moderately severe injuries.

---

**ATTENTION**  
**Physical damage**

Failure to comply can cause physical damage.

---



Notes for better understanding and operation of the unit.

---

Symbol / sign	Meaning
•	Listing of information.
→	Action steps, which can be performed in any sequence.
1. 2.	Action steps, which must be performed in the specified sequence.
↳	Result of an action performed or additional information about it.



## 1.2 Intended use

This unit is intended to be used solely for commercial purposes, particularly in commercial kitchens.

This unit may only be used with suitable accessories and for the cooking of food.

**It is forbidden to use the unit for purposes, which include the following:**

- Drying cloths, paper or dishes
- Heating rooms
- Heating acids, alkaline solutions or other chemicals
- Heating flammable liquids
- Heating of closed containers (for example preserves)
- Keeping food warm
- Cooking noodles, potatoes, vegetables or other food being cooked in salt water
- Cooking soups and sauces
- Melting of fats and salts
- Thawing of frozen food

**The use of the unit is prohibited in the following countries:**

- USA
- Canada

## 1.3 Guarantee, warranty and liability

The warranty is void and safety is no longer assured in the event of:

- Improper conversion or technical modifications of the unit,
- Improper use,
- Incorrect startup, operation or maintenance of the unit,
- Problems resulting from failure to observe these instructions.

## 2 Safety information

The unit complies with applicable safety standards. Residual risks associated with operation or risks resulting from incorrect operation cannot be ruled out and are mentioned specifically in the safety instructions and warnings.

The operator must be familiar with regional regulations and observe them.

**Operation** Individual below 16 years of age are not allowed to operate the unit.

During operation, the following group of individuals must be supervised by an individual who is responsible for safety:

- Individuals with physical, sensory, or mental handicaps, or who lack the knowledge and experience to operate the unit properly.

The supervising individual must be familiar with the unit and the risks associated with it.

### **Hot surfaces Risk of burns from hot surfaces**

- Protect arms and hands by wearing suitable protective gloves.
- Do not touch heating elements, hot surfaces or accessories immediately after use.
- Allow surfaces to cool prior to cleaning.

### **Hot liquids Risk of burns from hot liquids**

- Protect arms and hands by wearing suitable protective gloves.
- Remove, transport and empty baskets carefully.
- Observe the maximum filling quantity.
- Open the drain carefully and empty the unit.

### **Risk of scalding from hot oil**

- Protect arms and hands by wearing suitable protective gloves.
- Prior to deep frying, remove excess ice from frozen foods to be cooked.
- Prior to deep frying, dry wet foods to be cooked.

### **Risk of chemical burns from evaporating cleaners**

- Follow the instructions of the cleaning agent manufacturer.

### **Risk of burns from steam**

- Protect arms and hands by wearing protective gloves.
- Open the drain carefully and empty the unit.
- Dry unit completely after cleaning it.

### **Defective unit Risk of injury from a defective unit**

- Use gas shut-off valve to isolate unit from gas supply.

- Do not operate a defective unit.
- Allow only an authorized technician to repair the unit.

**Escaping gas or exhaust gas Risk of asphyxiation and explosion from escaping gas**

- Follow the rules of conduct when the smell of gas is detected (see "Rules of conduct when the smell of gas is detected").

**Risk of asphyxiation and poisoning from exhaust gases**

- Ensure that air inlet openings are free and that a sufficient amount of the necessary combustion air is supplied.
- Ensure that the exhaust gas outlet openings are free and that the exhaust gases are discharged properly.

**Fire prevention Risk of fire from dirt and grease deposits**

- Clean the unit when finished using it.
- When the oil starts to become rancid, replace the deep-frying oil completely; do not add oil.

**Risk of fire from overheating**

- Observe the unit during operation.
- Observe the maximum filling quantity.
- Observe the minimum filling quantity.

**Risk of fire from objects**

- Do not obstruct the exhaust gas duct.

**Firefighting**

- In the event of a fire, use the gas shut-off valve to isolate the unit from the gas supply.
- Use a Fire Class F fire extinguisher, never water, to extinguish grease fires. Other fires, for instance, can be extinguished with fire extinguishers suitable for Fire Classes A, B, C, CO<sub>2</sub> fire extinguishers or extinguishing media suitable for the fire class confronted.

**Unit on casters Risk of injury from a unit on casters**

- Attach units with a wall side narrower than 600 mm to the wall at the installation site.
- Move the unit only for cleaning or maintenance.
- Lock casters during operation.
- Only move an empty unit.

**Risk of a line breaking if subjected to high tensile load**

- Secure the unit with a chain as a strain relief for the power connection at the installation site so that no tensile load is applied to the power connection if the unit is moved.

### **Improper cleaning Risk of chemical burns from cleaning agent**

- Follow the instructions of the cleaning agent manufacturer.
- Take appropriate protective measures when handling aggressive cleaning agents.

### **Risk of falling on smooth floors**

- Keep the floor in front of the unit clean and dry.

### **Risk of injury from improper cleaning**

- Dry the unit completely after cleaning it.

### **Risk of physical damage from improper cleaning**

- Clean the unit after using it.
- Do not clean the unit with a high-pressure cleaner or water jet.
- Do not clean the housing with highly abrasive or chemically aggressive cleaning agents.
- Do not clean the housing with highly abrasive sponges.
- Follow the instructions of the cleaning agent manufacturer.
- Do not cool shock the unit by cooling it abruptly.

### **Hygiene Hygiene risk from rancid oil**

- When the oil starts to become rancid, replace the deep-frying oil completely; do not add oil.

### **Health risk from insufficient hygiene**

- Observe applicable regional hygiene regulations.
- Follow the cleaning instructions.

### **Improper use Risk of physical damage from improper use**

- Do not operate the unit outdoors.
- Use only original accessories.
- Train operators regularly.
- Do not heat food warmer plates or tins of preserved food.
- Observe the unit during operation.
- Do not melt solid deep-frying oil in the deep-frying pan.
- Use only commercially available deep-frying oils when operating the unit.

### 3 Rules of conduct when the smell of gas is detected

---



**DANGER**

**Risk of asphyxiation and explosion from escaping gas**

Follow the rules of conduct when the smell of gas is detected.

---

- Remain calm.
- Open windows and doors and ventilate rooms.
- Avoid rooms with the smell of gas.
- Do not smoke.
- Do not ignite any flames. Extinguish flames.
- Do not create any sparks. Do not operate any switches, electrical devices or use telephones.
- Remove mobile phones and radio-controlled devices from the hazard area.
- Close gas shut-off valves at the gas meter, at the main supply and, if possible, at the units.
- Warn other individuals in the building. Call out and knock, do not ring doorbells.
- Leave the building and prevent entry by others.
  - Notify the gas utility stand-by service.
  - Do not try to eliminate damage to the gas system by yourself.
- Observe the safety instructions of the gas utility.
- Once outside the building, notify the responsible parties:
  - If the smell of gas comes from the unit, notify Customer service.
  - If the source of the gas smell can not be localised immediately, notify the gas utility.
  - If the escaping gas is audible, leave the building immediately, prevent others from entering and notify the fire brigade, police and gas utility.
  - If the smell of gas comes from inaccessible rooms, notify the fire brigade, police and gas utility.

## 4 Description of the unit

The unit is intended for universal use in commercial kitchens for cooking food. The unit may only be used for deep-frying starch- and protein-containing food with suitable deep-frying oils.

### 4.1 Overview of the unit

#### 4.1.1 Floor-standing unit

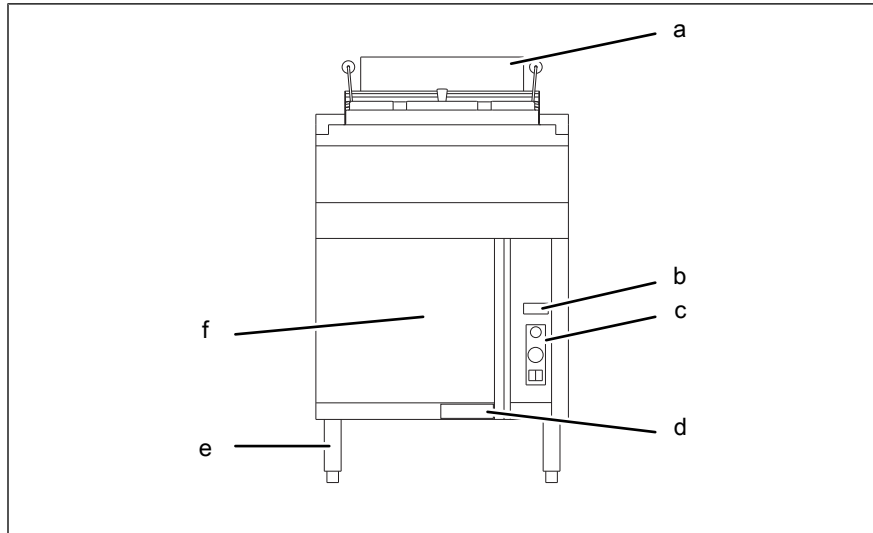





Image: OPGFRIPG floor-standing unit

- |                       |  |
|-----------------------|--|
| a Exhaust gas duct    | d Nameplate and gas type supplementary label |
| b Temperature display | e Equipment leg                              |
| c Operating elements  | f Drain (covered)                            |

### 4.2 Function of the operating and display elements

Symbol	Operating/display element	Function
	<i>Ignition On</i> button	<ul style="list-style-type: none"> <li>Switches on the gas supply</li> </ul>
	<i>Off</i> button	<ul style="list-style-type: none"> <li>Switches off the gas supply</li> </ul>
	<i>Output</i> control knob	<ul style="list-style-type: none"> <li>Supplies the pilot burner</li> <li>Operating pause</li> </ul>
"1 — 8"		<ul style="list-style-type: none"> <li>Sets the output</li> </ul>
	<i>Piezo pilot ignitor</i> button	<ul style="list-style-type: none"> <li>Ignites the flame</li> </ul>

### 4.3 Fill quantities

Unit	Maximum fill quantity of oil (l)
Prague	28

## 4.4 Operating temperature

Control setting	1	2	3	4	5	6	7	8
Frying temperature (approximate indication in °C)	60	80	95	115	130	150	170	185

### 4.4.1 Recommended cooking temperature and cooking time

Food to be cooked	Cooking temperature (°C)	Cooking time (minutes)
Doughnuts	170	3 — 4
Cauliflower	170	2 — 3
Fish fillet	170	2 — 6
Trout	160	2 — 4
Chicken, portioned	170	3 — 8
Quick-frying food	170	2 — 4
Chips, pre-blanched and deep-frozen	180	3 — 5
Chips, pre-blanched and defrosted	180	2 — 3
Fried pastries	180	2 — 3
Onion rings	170	1 — 3

## 5 Operating the unit

### 5.1 Switching the unit on and off

#### 5.1.1 Switching on

**Requirements** Deep-frying oil filled up to the bottom fill level mark

1. Open the gas shut-off valve.
2. Press and hold the *Ignition* button.
3. Press the Piezo pilot ignitor.
4. Observe the ignition procedure through the inspection port.  
↳ The flame burns.
5. After 3 seconds let go of the *Ignition* button.



If there is no ignition, repeat the procedure.

---

#### 5.1.2 Switching off



It is only possible to put the oven into operation again after the safety time has elapsed. The safety time is about 60 seconds.

---

1. Press the *Off* button.  
↳ The pilot burner switches off.  
↳ The unit is off.

### 5.2 Pausing and end of use

#### 5.2.1 Short pause



When restarting the unit after pauses, first check the function of the pilot burner in order to prevent a flash fire.

---

1. Turn the *Output* control knob to the "☆" setting.  
↳ The burner is switched off.  
↳ The pilot burner remains on.
2. Turn the *Output* control knob to the "1 — 8" setting.  
↳ The burner is ignited.

#### 5.2.2 Longer pauses and end of use



After being out of operation for a longer period of time, the unit must be checked by an expert, who is approved by the gas utility.

---



1. Turn the *Output* control knob to the "☆" setting.
  - ↳ The burner is switched off.
  - ↳ The pilot burner remains on.
2. Press the *Off* button.
  - ↳ The pilot burner is now off.
  - ↳ The unit is now off.

### 5.3 Handling deep-frying oil



**DANGER**  
**Risk of explosion from hot oil or fat**

Risk of a fat explosion when extinguishing burning fat or oil with water or an extinguishing agent that contains water.

- Always use a **Fire Class F** fire extinguisher to extinguish fat fires.
- Smother the flame with a flame-retardant fire blanket.
- Never extinguish burning fat with water!



**CAUTION**  
**Hygiene risk from fat residue**

Fat residue is a hygiene risk.

- Avoid fat residue underneath the heating element.
- When replacing the fat, warm it to a temperature of maximum 100 °C.
  - ⇒ Stir the fat with a suitable implement until it has reached temperature, so that the fat underneath the heating element is completely liquefied.



**CAUTION**  
**Risk of burns from hot oil or fat that is foaming over**

The use of old fat or fat with a high proportion of frying or coating residue increases the risk, that hot fat will foam over.

- Clean or replace fat in accordance with the manufacturer's instructions.



**CAUTION**  
**Risk of burns from emptying hot oil or fat**

- Before emptying fat, allow it to cool to a temperature of < 100 °C.
  - ⇒ Fill hot fat or oil into heat-resistant containers.
  - ⇒ Only decant oil or fat into plastic containers after it has cooled down, so that the containers are not damaged.



---

### **CAUTION**

#### **Hygiene risk from rancid oil**

- When the oil starts to become rancid, replace the deep-frying oil completely; do not add oil.
  - Observe the manufacturer's information regarding the duration of use of the deep-frying oil.
- 

### **ATTENTION**

#### **Risk of fire from hot oil or fat**

Spontaneous combustion of hot fat or oil can occur above approximately 350 °C.

The greater the proportion of frying or coating residue, the higher the risk of fire.

- Do not leave the unit unattended.
  - Do not overheat the fat.
  - "Smoking" fat means an increased risk of fire.
  - Clean or replace fat in accordance with the manufacturer's instructions.
- 

### **ATTENTION**

#### **Risk of fire from hot oil or fat**

Old oil or fat has a lower ignition point.

The use of old fat or oil increases the risk of fire.

- Do not overheat the fat.
  - "Smoking" fat means an increased risk of fire.
  - Clean or replace fat in accordance with the manufacturer's instructions.
- 

### **5.3.1 Ensuring that the oil is fit for human consumption**

Deep-frying oil counts as food. It must be fit for human consumption.

The suitability of the deep-frying oil for human consumption can be checked with quick-tests from specialist shops (e.g. 3M oil test strip).

The suitability of the deep-frying oil for human consumption can be extended by the following measures:

- Shake loose breadcrumbs from breaded food, before the food is fried.
- Do not overheat deep-frying oil (160 – 180 °C is sufficient).
- Cover the unit with the lid during pauses.
- Do not reduce the temperature of the deep-frying oil below 120 °C during longer interruptions in operation.
- Deep-frying oil that has been consumed during operation should be supplemented by the amount consumed.
- Replace the deep-frying oil before it becomes rancid.

- Filter the deep-frying oil.
- Clean the unit carefully.
- Empty, clean and cover the unit when unused.
- If the deep-frying oil is not being used, store it hermetically sealed and cool away from light.

Collect rancid deep-frying oil in suitable containers and dispose of it properly in accordance with the regulations.

## 5.4 Filling the deep-frying oil



### WARNING

#### Risk of burns from the oil

The deep-frying oil can ignite, if the minimum fill quantity is not met.

- Observe the fill level mark.

**Requirements** Unit switched off and cooled down  
Drain closed

1. Remove the lid.
2. Warm solidified deep-frying fat in a saucepan before pouring in.
3. Fill the deep-frying oil in the quantity required for the food to be cooked.

### 5.4.1 Gently heating up deep-frying oil

To extend the useful life of the deep-frying oil, do not use the highest temperature setting when first heating the oil at the start of work. The oil should be heated slowly.

## 5.5 Deep-frying



### CAUTION

#### Risk of injury from deep-frying oil foaming over

- Protect arms and hands by wearing suitable protective gloves.
- Briefly defrost and dry any frozen food to be cooked.
- Dry wet food to be cooked.
- Do not exceed the maximum fill quantity for the food being cooked.

### Tip

Observe the recommended cooking temperature and cooking time when deep-frying.

- Requirements** Drain closed  
Filled with deep-frying oil  
The unit is on
1. Set the temperature.
    - ↳ The deep-frying fat is heated.
    - ↳ The burner switches off, after the cooking temperature is reached.
  2. Load the food to be cooked into the deep-frying basket.
    - ↳ Do not exceed the maximum fill quantity for the deep-frying baskets.
    - ↳ Observe the recommended cooking temperatures and cooking times when deep-frying.
  3. Insert the deep-frying basket into the deep-frying tank.
    - ↳ The deep-frying starts.
  4. Deep fry the food to be cooked.
  5. Lift the deep-frying basket out of the deep-frying tank and allow the oil to drip off.

### 5.6 Emptying the deep-frying oil



---

**WARNING**  
**Risk of burns from escaping hot fat**

Below the unit there must always be a heat-resistant vessel with sufficient capacity to take the fat.

Close the drain tap during operation.

---



---

**CAUTION**  
**Risk of burns from hot surfaces**

- Protect arms and hands by wearing suitable protective gloves.
  - Do not touch heating elements, heating surfaces or accessories during and immediately after the test.
- 

- Requirements** Deep-frying fat is liquid  
Unit switched off  
Deep-frying basket removed
1. Place a suitable collection container underneath.
  2. Open the drain slowly.
  3. Empty the deep-frying oil.
  4. Close the drain.
  5. Close the lid on the collection container when transporting.
  6. Collect rancid deep-frying oil in suitable containers and dispose of it properly in accordance with the regulations.

## 6 Cleaning and caring for the unit



### WARNING

#### Risk of scalding from hot steam

Hot deep-frying oil causes residual water to vaporise explosively.

- Dry deep-fat fryers completely after cleaning.



### CAUTION

#### Risk of burns from hot surfaces

- Allow surfaces to cool prior to cleaning.

### ATTENTION

#### Risk of physical damage from improper cleaning

- Do not clean the unit with a high-pressure cleaner or water jet.

### 6.1 Preventing corrosion

- Keep the surfaces of the unit clean and with access to air.
- Remove lime, grease, starch and protein deposits.
- Only expose parts made from non-rusting steel to brief contact with highly acidic foods, spices, salts or the like.
- Avoid damaging the stainless steel surface with other metal items, for example steel spatulas or steel wire brushes.
- Prevent contact with iron and steel, for example steel wool and steel spatulas.
- Do not use bleaching or chlorine-containing cleaning agents.
- Clean contact surfaces with water.

### 6.2 Removing rust spots

- Remove fresh rust spots with a mild abrasive or fine sandpaper.
- Always remove rust spots completely.
- Expose treated areas to fresh air for at least 24 hours. During this time, do not allow any contact with greases, oils or foods so that a new protective layer can form.

### 6.3 Cleaning the housing

**Requirement** Unit switched off and cooled down

- Clean the housing with warm water and commercially available washing-up liquid.

### 6.4 Cleaning the deep-frying basin

**Requirements** Deep-frying oil emptied

Unit switched off and cooled down

1. Close the drain.
2. Place a suitable collection container underneath.
3. Remove the deep-frying basket.
4. Lift the oil clarifying tray carefully out of the deep-frying tank and empty it.
5. Thoroughly clean the deep-frying tank, deep-frying basket and oil clarifying tray with warm water and a mild cleaning agent.
6. Let the cleaning water drain away.
7. Rinse with clear water and then dry thoroughly.
8. Clean the drain and discharge pipe thoroughly (see "Cleaning the drain").
9. Empty the collection container.
10. Hook in the oil clarifying tray.
11. Insert the deep-frying basket.
12. Put the lid on.

### 6.5 Cleaning the heating elements

**Requirements** Deep-frying oil emptied

Unit switched off and cooled down

1. Close the drain.
2. Place a suitable collection container underneath.
3. Load in the water up to the *Maximum fill level* mark.
4. Switch on the unit and heat the water to 90 °C.
5. Switch off the unit.
6. Allow incrustation to soak for approx. 30 minutes.
7. Open the drain slowly and allow the water to run into the container.
8. Close the drain.

### 6.6 Cleaning the drain

**Requirement** Unit switched off and cooled down

Basin emptied

1. Open the drain.
2. Clean the drain thoroughly with a bottle brush.
3. Clean the drain with clear water.
  - ↳ Use a mild cleaning agent if required.
  - ↳ Rinse thoroughly with clear water.
4. Wipe dry with a lint-free cloth.
5. Close the drain.
  - ↳ Ensure that no water remains in the drain.

## 7 Troubleshooting



### DANGER

#### Risk of fatal injury from escaping gas

- Gas installation work on the gas system and unit may only be performed by an expert approved by the gas utility. The applicable regional regulations of the gas utility must be observed.

### 7.1 Cause of failure and the remedy

Failure	Possible causes	Remedy
The unit does not react	Operating element defective	<ul style="list-style-type: none"> <li>• Close the gas shut-off valve.</li> <li>• Contact Customer service.</li> </ul>
	Ambient temperature is below 0 °C, the safety temperature limiter has tripped	<ul style="list-style-type: none"> <li>• Close the gas shut-off valve.</li> <li>• Contact Customer service.</li> </ul>
The unit does not heat up	Unit is defective	<ul style="list-style-type: none"> <li>• Close the gas shut-off valve.</li> <li>• Contact Customer service.</li> </ul>
	Ventilation system switched off	<ul style="list-style-type: none"> <li>• Switch on the ventilation system.</li> <li>• Contact Customer service.</li> </ul>
	Gas supply interrupted	<ul style="list-style-type: none"> <li>• Open the gas shut-off valve.</li> <li>• Contact Customer service.</li> </ul>
	The unit is switched off	<ul style="list-style-type: none"> <li>• Switch on the unit.</li> </ul>
	Temperature control knob on the ☆ setting	<ul style="list-style-type: none"> <li>• Set the temperature.</li> </ul>
Insufficient heat output	Valve defective	<ul style="list-style-type: none"> <li>• Close the gas shut-off valve.</li> <li>• Contact Customer service.</li> </ul>

### 7.2 Nameplate

When contacting Customer service, please always provide the following data from the nameplate:

Serial number (SN)	
Type number (TYP)	

## 8 Carrying out maintenance

The unit is maintenance-free, there are no maintenance requirements.



## 9 Disposing of the unit in an environmentally responsible manner

Do not dispose of unit or the unit's components together with non-recyclable waste. If the unit is disposed of together with non-recyclable waste or treated improperly, toxic substances contained in the unit can damage health and pollute the environment.

Dispose of the unit in accordance with local regulations for used appliances. Clarify any open questions with the responsible agencies (for instance, solid waste management).

**Oil and fat** Residue that contains oil and fat must be collected in suitable containers and disposed of in accordance with the local disposal regulations.

**Cleaning agents** Dispose of leftover cleaning agents and cleaning agent containers in accordance with the information provided by the cleaning agent's manufacturer. Observe applicable regional regulations.

**Unit** In addition to valuable materials, used electrical and electronic equipment also contains harmful substances that were needed for their operation and safety.

# 10 Manufacturer's declaration



## EC Declaration of Conformity



**Manufacturer**

MKN Maschinenfabrik Kurt Neubauer GmbH & Co. KG • Halberstädter Straße 2a • 38300 Wolfenbüttel, Germany

We hereby declare, that the following product:

Description of the unit			
Unit for cooking food in commercial applications			
Designation / Unit type			
Gas deep-fat fryer / XXGFRI...			
Unit number			
1260302	2060301	1260301	

complies with the relevant provisions of the following directives and regulations, but does not contain any assurance of properties:

- Directive 2009/142/EC, dated 30 November 2009, relating to appliances burning gaseous fuels
- Directive 2011/65/EU (RoHS) dated 01 July 2011
- REGULATION (EC) No. 1935/2004 dated 27 October 2004 on materials and objects, which are intended to come into contact with food

We hereby declare, that the listed units comply with the type of construction described in the EU Type Examination Certificate, and that they meet the requirements of the specified Gas Appliances Directive.

Product identification number of the EU type examination certificate:  
CE-0085CL0516

Adduced basis for verification	
EN 203-1:2014	
EN 203-2-4:2006	
EN 203-3:2009	

The manufacturer bears the sole responsibility for issuing this Declaration of Conformity. This Declaration of Conformity becomes invalid, if changes are made which are not agreed with us.

Translation from the original document • 2060301--0KODE--

Wolfenbüttel, 07/06/2017

Person authorised to compile the technical documents:

ppa. Peter Helm, Chief Technical Officer (address as manufacturer)





[www.mkn.eu](http://www.mkn.eu)

